

P-97

Flaming/Brown™ Micropipette
Puller

Operation Manual

Rev. 2.43 - INT (20161118)



SUTTER INSTRUMENT®

One Digital Drive
Novato, CA 94949

Voice: 415-883-0128 Web: www.sutter.com
Fax: 415-883-0572 Email: info@sutter.com



Copyright © 2016 Sutter Instrument Company. All Rights Reserved.

Flaming/Brown™ is a trademark of Sutter Instrument Company.

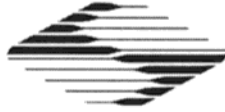

CE DECLARATION OF CONFORMITY

Application of Council Directives:
89/336/EEC (EMI/EMC), Amended by 93/68/EEC (LVD), and 2011/65/EU (RoHS 2)

Manufacturer's Name: Sutter Instrument Company

Manufacturer's Address: One Digital Drive
Novato, CA. 94949 USA
Tel: +1 415 883 0128

Equipment Tested: P-97 Micropipette Puller

Model Name: P-97

Conforms to Standards: EMI/EMC: EN 55011, Class B; CISPR 11, Class B,
EN 50082-1:1992 IEC 801-2:1991
IEC 801-3:1984 IEC 801-4:1991

LVD (Safety): EN61010-1: 1993
Tested By: TUV Product Service
10040 Mesa Rim Road
San Diego, CA 92121 USA

Year Tested: 1995, 1997

Sutter Instrument Company hereby declares that the equipment specified above was tested and conforms to the Directives and Standards listed above, and further certifies conformation to the requirements of the European Union's Restriction on Hazardous Substances in Electronic Equipment Directive 2011/65/EU (RoHS 2).

Project Engineer:

Jack Belgum, Ph.D.
Senior Vice President

SUTTER INSTRUMENT

ONE DIGITAL DRIVE, NOVATO, CA 94949 USA PHONE: +1 415 883 0128 FAX: +1 415 883 0572
EMAIL: INFO@SUTTER.COM WEB: HTTP://WWW.SUTTER.COM

DISCLAIMER

The pipette puller Model P-97 is designed for the specific use of creating micropipettes and no other use is recommended.

This instrument creates items that should only be used in a laboratory environment for use on animal tissues. It is not intended for use, nor should be used, in human experimentation, or applied to humans in any way. This is not a medical device.

Do not open or attempt to repair the instrument without expressed and explicit instructions from Sutter Instrument Company. Extreme heat and high voltages are present and could cause injury.

Do not allow unauthorized and or untrained operatives to use this device.

Any misuse will be the sole responsibility of the user/owner and Sutter Instruments assumes no implied or inferred liability for direct or consequential damages from this instrument if it is operated or used in any way other than for which it is designed.

SAFETY WARNINGS AND PRECAUTIONS

Electrical

- Operate the P-97 using 110-120 V AC (60 Hz) or 220-240 V AC. (50 Hz) line voltage. This instrument is designed for connection to a standard laboratory power outlet (Overvoltage Category II), and because it is a microprocessor--controlled device, it should be accorded the same system wiring precautions as any 'computer type' system. A surge protector and power regulator are recommended.

-  **Fuse Replacement:** Replace only with the same type and rating:

At 110 - 120 VAC:

Type: Medium Time Delay or Time Lag

Rating: 3A 250V (3 Amps, 250 Volts)

Examples: Bussmann GMC-3A or GMC-3-R; or
Littelfuse 239 003 or 239 003.P

At 220 - 240 VAC:

Type: Time Delay (IEC 60127-2, Sheet III)

Rating: T2A_250V (2 Amps, 250 Volts)

Examples: Bussmann GDC-2.0A, S506-2A, or S506-2R; or
Littelfuse 218 002 or 218 002.P)

A spare fuse is located in the power input module. Please refer to the fuse-replacement appendix for more details on fuse ratings and for instructions on how to change the fuse.

Avoiding Electrical Shock and Fire-related Injury

-  Always use the grounded power supply cord set provided to connect the system to a grounded outlet (3-prong). This is required to protect you from injury in the event that an electrical hazard occurs.



- Do not disassemble the system. Refer servicing to qualified personnel.
-  To prevent fire or shock hazard do not expose the unit to rain or moisture.

Back Injury Prevention

To avoid injuring your back or limbs it is recommended that you do not attempt to lift this instrument by yourself. The P-97 Micropipette Puller weighs in excess of 18 kg (over 39 lb) and should be moved by TWO (2) people.

Operational

Failure to comply with any of the following precautions may damage this device.

- Operate the P-97 using the indicated line voltage.
- The P-97 is designed for operation in a laboratory environment (Pollution Degree II) and at temperatures between 5°C - 40°C.
- The P-97 is designed for connection to a standard laboratory power outlet (overvoltage Category II) with main supply voltage fluctuations not to exceed $\pm 10\%$ of the normal voltage.
- This unit is not designed for operation, nor has it been tested for safety, at altitudes above 2000 meters (6562 feet).
- This unit was designed to operate at maximum relative humidity of 80% for temperatures up to 31°C decreasing linearly to 50% relative humidity at 40°C.
-  Operate only in a location where there is a free flow of fresh air on all sides. The fan draws air in through the vents on the sides and exhausts out both ends of the heat sink. NEVER ALLOW THE FREE FLOW OF AIR TO BE RESTRICTED.
-  To avoid burns do not touch the heating filament, the brass clamps holding the filament, or the heated ends of glass pipettes that have been pulled.
- Only use Sutter Instrument Company replacement heating filaments.

Handling Micropipettes

 Failure to comply with any of the following precautions may result in injury to the users of this device as well as those working in the general area near the device.

- The micropipettes created using this instrument are very sharp and relatively fragile. Contact with the pulled micropipette tips, therefore, should be avoided to prevent accidentally impaling yourself.
- Always dispose of micropipettes by placing them into a well-marked, spill-proof “sharps” container.
- Use only with capillary glass (tubing) recommended by Sutter Instrument (see 1.2.1 Glass Capillary).

TABLE OF CONTENTS

DISCLAIMER	iii
SAFETY WARNINGS AND PRECAUTIONS	iii
Electrical	iii
Avoiding Electrical Shock and Fire-related Injury	iii
Back Injury Prevention	iv
Operational	iv
Handling Micropipettes.....	iv
1. GENERAL INFORMATION	1
1.1 What's New on the P-97?.....	1
1.2 Glass Capillary & Heating Filament Specifications.....	2
1.2.1 Glass Capillary.....	2
1.2.2 Heating Filament	2
1.3 Technical Support.....	2
1.4 System Description – Front Panel	2
1.4.1 Controls	3
1.4.2 Display	3
1.5 System Description – Mechanical (Puller Anatomy)	5
1.5.1 Some Basic Information	5
1.5.2 Air Cooling System.....	5
1.5.3 Heating Assembly	5
1.5.4 Upper Pulley Assembly	7
1.6 Cabinet.....	8
1.6.1 Electronics.....	8
2. INSTALLATION	9
2.1 Unpacking.....	9
2.2 Setting Up.....	9
2.2.1 Line Power (Mains).....	9
3. OPERATING INSTRUCTIONS	11
3.1 First Time Use	11
3.2 Programs.....	12
3.2.1 Program Structure.....	12
3.2.2 Program Line Pull Cycle Parameters	12
3.2.3 Pull Cycle	14
3.2.4 Default Configuration.....	14
3.2.5 Selecting a Program (0 to 99).....	14
3.2.6 Viewing a Program (< NEXT > / < LAST >)	15
3.2.7 Clearing a Program from Memory (< CLR >).....	15
3.2.8 Editing a Program.....	15
3.2.8.1 Entering a New Program	16
3.2.8.2 Editing an Existing Program	16
3.3 Software Control Functions.....	16
3.3.1 RAMP TEST < 1 >	17
3.3.2 CHANGE AIR PRESSURE < 2 >	18

3.3.3 AIR MODE < 3 >	18
3.3.4 AIR TIME AT START OF PULL < 4 >	19
3.3.5 AIR TIME AT END OF PULL < 5 >	19
3.3.6 RESET TIME AND DATE < 6 >	19
3.3.7 WRITE-PROTECT THE PROGRAM < 7 >	19
3.3.8 MEMORY TEST < 8 >	20
3.4 Pulling Pipettes	20
3.4.1 Procedures	20
3.4.2 Notes on Program Operation	21
3.5 Parameter Adjustment	21
3.5.1 General Information	21
3.5.2 Micropipette/Microinjection Needle Fabrication	22
3.5.2.1 HEAT	22
3.5.2.2 PULL Strength	22
3.5.2.3 VELOCITY (Trip Point)	22
3.5.2.4 TIME Mode (Cooling)	23
3.5.2.5 Delay Mode (Cooling)	23
3.5.2.6 PRESSURE Adjustment	24
3.5.2.7 Filament Width	24
3.5.3 Patch Pipette Fabrication	24
3.5.3.1 HEAT	24
3.5.3.2 PULL Strength	25
3.5.3.3 VELOCITY (Trip Point)	25
3.5.3.4 Cooling	25
3.5.3.5 PRESSURE	25
3.5.4 Step-by-Step Patch Pipette Programming	25
3.5.5 Technical Tips for Pulling Micropipettes	27
3.5.5.1 Regulating the Time it takes to pull a Sharp Pipette	27
3.5.5.1.1 Pipette Position	27
3.5.5.2 Regulating the Length and Tip Size of a Sharp Pipette	27
3.5.5.2.1 Filament Width	27
3.5.5.2.2 Air Flow	27
3.5.5.2.3 DELAY Mode of Active Cooling	27
3.5.6 Fire Polishing	28
3.6 Heating Filaments	29
3.6.1 General Information	29
3.6.2 Filament Positioning and Aligning	29
3.6.3 Box Filament	30
3.6.3.1 Positioning	30
3.6.3.2 Geometry	31
3.6.4 Trough Filament	31
3.6.4.1 Positioning	32
3.6.4.2 Geometry	32
4. MAINTENANCE	33
4.1 Cleaning	33
4.2 Heating Filament Replacement	33
4.2.1 Filament Replacement (Step by Step)	33
4.2.2 Air jet Position	33

4.2.3 Positioning the Filament in Relation to the Glass Capillary	33
4.3 Pulley Adjustment	35
4.4 Regeneration of Drierite Granules.....	36
4.4.1 Removing the Canister	36
4.4.2 Replacing the Granules	36
4.4.3 Reinstalling the Canister.....	37
5. TROUBLESHOOTING	39
5.1 Controlling Pipette Tip Shapes	39
5.1.1 Problem: What type of glass should be used?	39
5.1.2 Problem: The resistance of pulled pipettes is too low. How can a higher-resistance pipette be pulled?	39
5.1.3 Problem: Okay, but how can tips be made even smaller.	39
5.1.4 Problem: How can the size of a patch-pipette be increased?.....	40
5.1.5 Problem: Patch-pipette tips vary in size from pull to pull.....	40
5.1.6 Problem: Difficulty making an injection pipette with a 0.5 – 1 mm tip that also has a very short final taper and tip (20 to 50 mm long). How can this be done?	40
5.1.7 Problem: The electrodes are bent. How can they be made to pull straight?.....	40
5.1.8 Problem: One electrode is much longer than the other electrode.	40
5.1.9 Problem: The shape and resistance of the pipette changes from pull to pull.....	41
5.2 Controller problems.....	41
5.2.1 Problem: The filament does not light up when pull is pressed.	41
5.2.2 Problem: Display blank, fan not on, or locked up/overlap.....	42
5.2.3 Problem: Display shows only shows a cursor.....	42
5.2.4 Problem: Displayed program values are not correct	42
5.3 Technical Support.....	42
APPENDIX A. Limited Warranty.....	43
APPENDIX B. Accessories.....	45
Filaments	45
Capillary Glass Tubing.....	45
Other Accessories.....	45
APPENDIX C. Fuse Replacement.....	47
APPENDIX D. Technical Specifications.....	49
APPENDIX E. Drierite Material Safety Data Sheet	51
INDEX	53

TABLE OF FIGURES

Figure 1-1. P-97 Front panel.	2
Figure 1-2. Program Display.	3
Figure 1-3. P-97 base plate (top view, cover removed).	5
Figure 1-4. Filament Block Assembly.	6
Figure 1-5. Upper cable pulley assembly.	7
Figure 2-1. P-97 Cabinet (rear view), showing power entry module.	10

Figure 2-2. P-97 Cabinet (end view, left), showing power switch.	10
Figure 2-3. Power connection.	10
Figure 3-1. Loading a piece of glass.	11
Figure 3-2. Power-on display.	14
Figure 3-3. P-97 Program display.	15
Figure 3-4. Clear Program Display.	15
Figure 3-5. Access to control functions.	16
Figure 3-6. Write protection default state.	20
Figure 3-7. Pull Cycle Report.	20
Figure 3-8. Sample program.	21
Figure 3-9. Pull cycle report (multiple-loops).	21
Figure 3-10. Side view of fire polishing spacer.	28
Figure 3-11. Fire Polish Spacer in Puller Bar.	29
Figure 3-12. Filament alignment.	29
Figure 3-13. End view of box filament and glass.	30
Figure 3-14. Box filament positioning.	31
Figure 3-15. End view of trough filament and glass.	31
Figure 3-16. Trough filament positioning.	32
Figure 4-1. V-Groove bearings and puller bars.	33
Figure 4-2. Filament alignment.	34
Figure 4-3. Micropipette shapes.	35
Figure 4-4. Pulley Adjustment.	36
Figure 5-1. Power entry module.	47
Figure 5-2. Fuse holder.	48

TABLE OF TABLES

Table 3-1. Standard factory configuration.	14
Table 3-2. Control Functions.	17
Table 3-3. Maximum heat and recommended starting values for different filament shapes.	18
Table 3-4. Box filament sizes.	31
Table 3-5. Trough filament sizes.	32

1. GENERAL INFORMATION

The P-97 can fabricate pipettes for use in intracellular recording, patch clamping, transferring (ICSI, ES Cells), microinjection, aspiration, and microperfusion. Realizing the full potential of this instrument is dependent on a complete understanding of the way it implements the pulling process. To this end, we urge that this manual be read in its entirety. To aid in understanding the function of the instrument, sample programs are already loaded in memory (as discussed in subsequent material).

The Model P-97 Flaming/Brown Micropipette Puller combines a proven pulling technology with programmability to produce a very versatile instrument. The pulling mechanism is derived from the P-77/P-80 series of pullers, which have demonstrated the ability to pull a complete range of pipette profiles. Added to this mechanism is the ability to program different pulling sequences; thus, allowing ease of use for pulling a multiplicity of pipettes on one device.

The P-97 is a 'velocity sensing' puller. This patented feature allows the puller to indirectly sense the viscosity of the glass, giving the P-97 the ability to pull pipettes from all glasses except quartz. Even difficult to pull formulations, such as aluminosilicate glasses, are handled with relative ease.

Throughout this manual reference will be made to the size of the glass tubing used to pull micropipettes. The convention used here for describing the outside diameter (O.D.) and inside diameter (I.D.) is as follows: O.D. x I.D. These dimensions will always be given in millimeters (mm). See our catalog or visit www.sutter.com to find a wide selection of glass capillaries available for purchase.

1.1 What's New on the P-97?

For users familiar with the P-80PC and/or P-87 pullers, the P-97 provides the advanced features incorporated into those instruments plus:

- Humidity controlled chamber surrounding the heating filament. Glass is now pulled in a constant humidity environment to minimize environmental effects on pipette reproducibility.
- Vacuum fluorescent display for improved readability
- 25% increase in available power
- Programmable air pressure
- Time of pull displayed at the end of each pull sequence
- Write protection to prevent programs from being corrupted
- Displayed date/time of last program edit
- Increased memory capable of storing 100 programs
- Switchable cooling mode (Time and Delay) to facilitate easy transfer of programs from both P-80PC and P-87 pullers

1.2 Glass Capillary & Heating Filament Specifications

1.2.1 Glass Capillary

The P-97 micropipette puller is designed for use with aluminosilicate, borosilicate or other lower melting-point glass tubing or rod ranging from 0.6 to 3.0 mm in diameter. This instrument does not pull quartz glass. Examples of the specific types and sizes of glass that can be used with the P-97 are listed in the Sutter Instrument Company catalogue that was included with this instrument or can be viewed on Sutter Instrument's web site at www.sutter.com. Any glass with comparable technical specifications can be used with the P-97.

1.2.2 Heating Filament

The type and size of glass that you choose may require a Heating Filament other than the one installed in your puller at the factory. Please refer to the Heating Filament section of this manual to determine the appropriate style and size of filament necessary for pulling the specific glass you would like to use. This instrument is designed to accommodate any of the Sutter Instrument Trough-type or Box-type filaments that are shown in the Sutter Instrument catalogue. This selection of replacement filaments can also be viewed on Sutter Instrument's web site at www.sutter.com.

ONLY USE SUTTER-SUPPLIED REPLACEMENT HEATING FILAMENTS IN THIS INSTRUMENT!

Systematic instructions for replacing the Heating Filament can be found in the Maintenance section of this manual.

1.3 Technical Support

Unlimited technical support is provided by Sutter Instrument Company at no charge to our customers. Our technical support staff is available between the hours of 8:00 AM and 5:00 PM (Pacific Standard Time) at (415) 883-0128. You may also Email your queries to info@sutter.com.

1.4 System Description – Front Panel

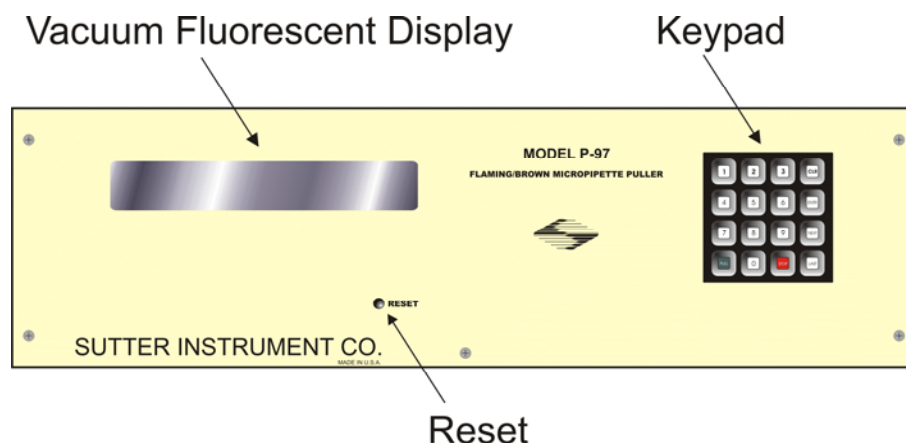

Figure 1-1. P-97 Front panel.

1.4.1 Controls

Vacuum Fluorescent Display	Displays program parameters.
Reset	Re-initializes the controller.
Keypad	Used to program parameter values and execute programs.
Keys:	
0-9	Used for choosing the desired program or control function, entering numeric values when programming and to make YES/NO (1/0) decisions.
CLR	Used to delete programs or numeric values entered into those programs. This key is also used to access the RAMP TEST.
ENTR	Used to enter new values.
NEXT	Used to move to the next line in a program while editing.
LAST	Used to move to the previous line in a program while editing.
PULL	Initiates the execution of a program.
STOP	Aborts the execution of a program.

1.4.2 Display

The P-97 has a two line vacuum fluorescent display for easy viewing from any angle. The following figure demonstrates what you will see after you have selected a program. A brief description of each parameter is provided below.

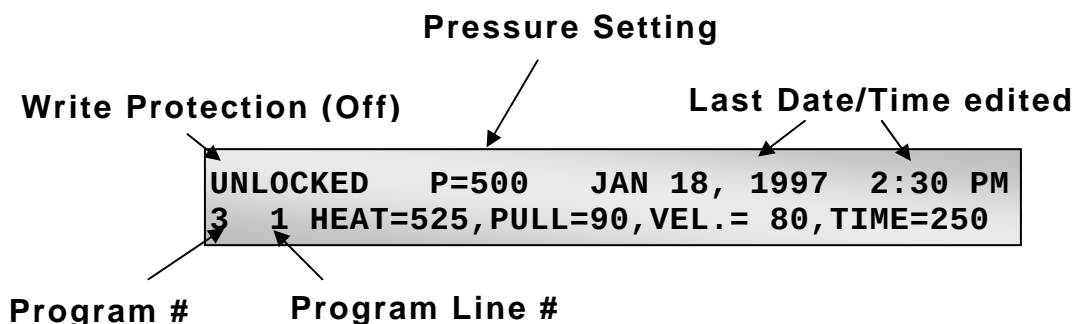

Figure 1-2. Program Display.

PROGRAM (0-99) A program consists of one or more cycles¹ which, when executed in sequence, will ‘pull’ the capillary glass inserted in the instrument. A program can be up to 8 cycles in length

¹ A **CYCLE** consists of four programmable parameters; **HEAT**, **PULL**, **VELOCITY** and either **TIME** or **DELAY**. A **CYCLE** is equivalent to one line of program code. The sequence of events during execution of a cycle is described in the **PROGRAMS SECTION** of this manual.

WRITE PROTECTION (Locked/ Unlocked)	"locked/unlocked"}Prevents program from being edited when in Locked mode.
PRESSURE SETTING (Range 0-999)	Reports the programmed value of the air pressure during the active cooling phase of the pull cycle.
DATE/TIME	Reports the date and time of the last program edit.
HEAT (Range 0-999)	HEAT controls the level of electrical current supplied to the filament. The HEAT required to melt a piece of glass is a function of the filament installed and the particular glass size and composition. It is important that the HEAT value be set relative to the Ramp Test value as discussed in the Operation Section. Generally, changes to HEAT will be made in steps of about 5 units since in most cases smaller changes will have little effect.
PULL (Range 0-255)	This parameter controls the force of the hard pull. In general, the higher the PULL, the smaller the pipette's tip diameter and the longer the taper. Useful changes in PULL strength are 10 units or more to see an effect.
VELOCITY (Range 0-255)	The velocity of the glass carriage system is measured as the glass softens and begins to pull apart under a constant load. The increasing velocity of the initial pull is determined by the viscosity of the glass, which in turn is a function of the glass temperature. The adjustable velocity allows for a selection of a precise glass temperature as the trip point for the hard pull. Useful values for velocity range from 10 to 150 with lower values being used for patch and injection pipettes and higher values for micropipettes. SEE THE PROGRAMS SECTION FOR A DISCUSSION OF THE SIGNIFICANCE OF VELOCITY=0.
TIME (Range 0-255)	TIME is one of two available modes of cooling and controls the length of time the cooling air is active. If VEL>0 then one unit of TIME represents 1/2ms. If VEL=0 then one unit of TIME represents 10ms. SEE THE PROGRAMS SECTION FOR A DISCUSSION OF THE SIGNIFICANCE OF TIME=0.
DELAY (Range 0-255)	DELAY is a cooling mode, which controls the delay time between when the heat turns off and when the hard pull is activated. The air is automatically turned on for 300ms. The higher the DELAY value, the cooler the glass will be when the hard pull is executed. Thus, increasing the DELAY results with decreased taper length and increased tip diameter. If VEL>0 then one unit of DELAY represents 1 (one) millisecond (ms). If VEL=0 (when using fire-polish mode), then one unit represents 10 (ten) ms. SEE THE PROGRAMS SECTION FOR A DISCUSSION OF THE SIGNIFICANCE OF DELAY=0.

1.5 System Description – Mechanical (Puller Anatomy)

1.5.1 Some Basic Information

This section presents a basic mechanical description of the P-97, with particular emphasis on terminology. Knowing the names of the various parts greatly facilitates communication between the investigators and the manufacturer when discussing adjustments or service problems. In addition, various controls and adjustments on the top of the instrument are located and described. Those adjustments, which are considered part of maintenance procedures, are dealt with in the Maintenance Section of this manual.

1.5.2 Air Cooling System

The Model P-97 supplies a blast of air to cool the filament area after the heating segment of a pull cycle. The components of the air-cooling system are shown below.

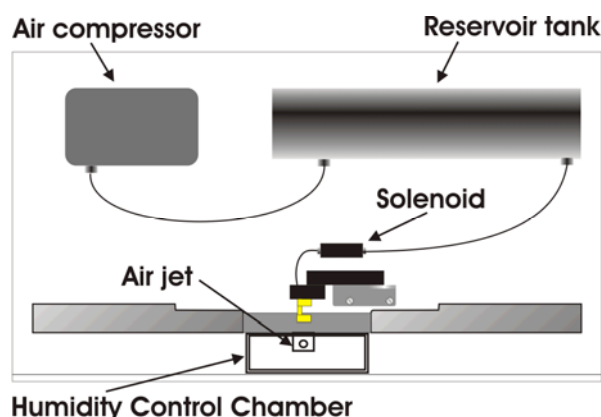

Figure 1-3. P-97 base plate (top view, cover removed).

Air Compressor	The air compressor (or pump) creates the air pressure used to cool the filament and glass during the pull cycle.
Air Jet	Directs the cooling air to the filament. The air jet should be positioned 2 to 3 millimeters below the filament. The screw that secures the air jet to the filament block can be loosened allowing the jet to move up and down.
Air Valve Solenoid	Regulates the flow of cooling air to the filament and glass.
Drierite Canister (Reservoir Tank)	A canister filled with Drierite used to remove moisture from the air flowing between the pump and the air solenoid. The dissected air is used to purge the Humidity Control Chamber before and after a pull, allowing the flow of dry air to cool the filament and glass during the pull cycle.

1.5.3 Heating Assembly

The **Heating Assembly** comprises the **Filament**, **Filament Block Assembly**, and the **Humidity Control Chamber**. The Filament Block Assembly and the Humidity Control Chamber are discussed below. Filaments are discussed in a separate section.

**Humidity Control Chamber
Figure 1-4)**

The chamber encloses the filament block assembly to provide a controlled environment in which to pull the glass. Access holes in the side of the chamber allow the glass to be loaded into position. The chamber must be removed to access the heating filament. To remove, unscrew the thumbscrew on the front plate of the chamber, remove the front plate, and then pull the chamber towards you.

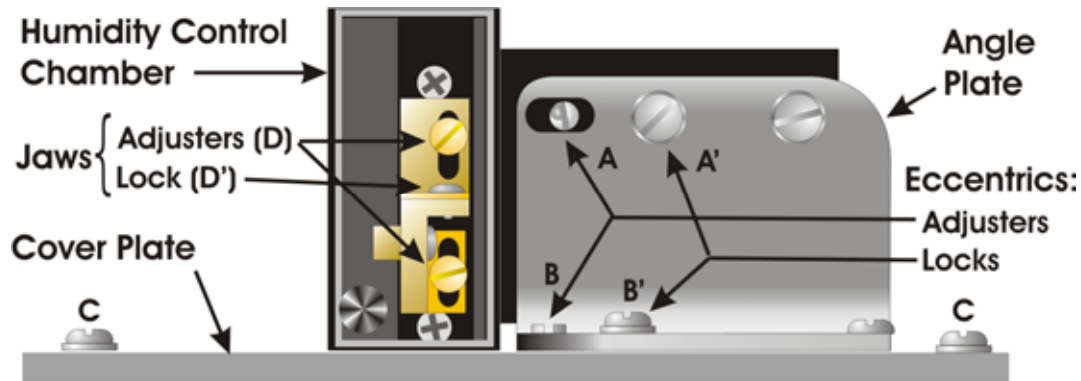

Figure 1-4. Filament Block Assembly.

**Filament Block Assembly
(Figure 1-4)**

The filament block assembly is made up of several pieces of hard black nylon. Wires supplying current to the filament are attached to threaded 'posts'. This current is carried to the filament via the upper and lower **Brass Jaws**. Note that these jaws may be moved up and down by loosening the screws (D) that secure them to the front of the filament block assembly. When changing the filament type from trough to box (or vice versa), the jaws must be moved up or down so that the filament is positioned at the correct level relative to the glass. If the jaws are repositioned and/or the filament type has been changed, make sure that the securing screws of the jaws and filament clamp are again tightened. Failure to tighten these screws can result in poor current flow for scorching and insufficient heat to melt the glass. Please refer to Filament Replacement in the Maintenance chapter for additional instructions.

**Eccentrics and Angle Plate
(Figure 1-4)**

The Angle Plate secures the Filament Block Assembly to the Cover Plate; it contains two eccentric adjustments. The two chrome-plated screws **A** and **B** are the eccentrics, and **A'** and **B'** are the corresponding locking screws. By turning the eccentrics with a screwdriver the Filament Block Assembly can be moved up and down (**A**) or forward and back (**B**) to adjust the position of the filament. Loosen the locking screw associated with each 'eccentric screw' before turning, and tighten after completing the adjustment. Note: Changing the eccentrics should be made only for **fine/small adjustments**.

Cover Plate (Figure 1-4) The cover plate conceals the entry of the Pulling Cables into the Base of the instrument. It is attached to the top by two screws, in slots, at points labeled C. Loosening these screws allows the Filament Block/Angle Plate assembly to move forward and back over large distances.

NOTE: The movements of the Cover Plate and the Jaws constitute the ‘coarse adjustments’ of filament position, while the eccentric screws allow ‘fine adjustments’.

1.5.4 Upper Pulley Assembly

This assembly guides the Pulling Cables (T in Figure 1-5) from the Puller Bars (G in Figure 1-5) to the centrally located (and concealed) Lower Cable Pulley Assembly. Note that the Upper Cable Pulley Assembly is attached to its panel by two screws, in slots (J' in Figure 1-5), and contains a large eccentric adjustment screw (J in Figure 1-5). This eccentric screw is used to adjust cable ‘tension’. Its use is covered in the Maintenance Section, and changes to the settings should not be performed without the supervision of Sutter Instrument Technical Support.

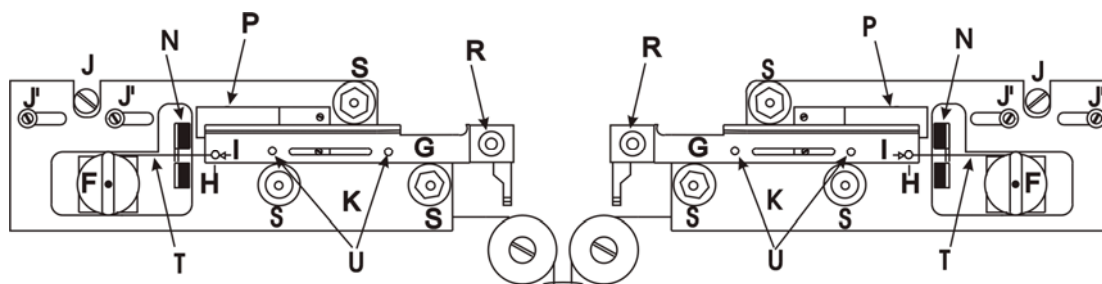

Figure 1-5. Upper cable pulley assembly.

Panels, Left And Right (K in Figure 1-5) The panels are the angled surfaces that provide mountings for the Puller Bars and their Bearings, the Spring Stops, the Bumpers, and the Upper Cable Pulley Assemblies. Except for minor differences in shape, the left and right Panels are mirror images of each other. Note the three socket-head cap screws that attach each Panel to the base plate top. These screws are used to align the Puller Bars. Their adjustment, if necessary, is covered in the Maintenance Section. Contact Sutter Instrument Technical Support for more instructions on how the panels are aligned.

Bumpers (N in Figure 1-5) The Bumper stops the motion of its associated Puller Bar. Each Bumper also prevents impact forces from breaking pipettes.

Spring Stops (P in Figure 1-5) The Spring Stops are one-way catches that catch the Puller Bars as they rebound off the Bumpers so as to prevent pipette tip collision.

Puller Bars (G in Figure 1-5) This assembly consists of the puller bar, threaded post, electrode clamp knob, and cable retaining screw. The cable retaining screw (H) holds the cable in a shallow groove (I) at the end of the puller bar, and forms the ‘resistance’ against which the cable ends pull. The puller bar is made of

mild steel and coated with a controlled thickness of hard chrome. Glass is loaded into the groove near the tip of the puller bar and is held in position by tightening down the clamping knob (**R**).

**V- Bearings
(S in Figure
1-5)**

These bearings are the guides for the Puller Bar motion. They are made of stainless steel and must **NEVER** be oiled (see Maintenance Section). Note that these bearings are mounted on stainless steel bushings, one of which is round with the other two being hexagonal. The hexagonal (eccentric) bushings are used to adjust position and ease of travel of the PULLER BARS (see Maintenance Section). Do not adjust the eccentrics without additional instruction.

**Pull Cable
(T in Figure
1-5)**

This cable transmits the pulling force of the solenoid to the Puller Bars via the Upper (**F**) and Lower Pulley Assemblies. It is made of flexible metal with a nylon coating. Never pinch or distort the cable. The cable is terminated with crimped-on clamps or 'swages' at the back-end of each Puller Bar.

**Glass Stop
Mounting (U
in Figure 1-5)**

Holes for mounting the glass stop. Either the left side or the right may be used.

1.6 Cabinet

Baseplate

The top thick metal plate on which the mechanical assemblies are mounted.

Base

The Base includes the cabinet to which the top Baseplate is mounted as well as the transformers and the circuit board contained within.

1.6.1 Electronics

The P-97 micropipette puller is controlled by a Z-80 microprocessor. Three digital-to-analog (D-A) converters control the HEAT, PULL, and VELOCITY values. The HEAT power supply is a precision constant current switching unit, which will vary less than 10 milliamperes with a plus or minus 10% change in the AC line current. The PULL supply is a constant current DC power supply. The velocity trip point is set by a D-A converter. The output of the velocity transducer is compared to the output of the velocity D-A to determine when the trip velocity is reached.

2. INSTALLATION

2.1 Unpacking

Make certain that you have received all of the following items in the P-97 shipping box:

- **P-97 micropipette puller***
- **Power cord**
- **Sample box containing the following types of glass:**
 - BF100-50-10 (Microinjection)
 - BF150-86-10 (Thick-Walled Patch (dissociated or cultured cells))
 - BF150-110-10 (Thin-Walled Patch (slice or whole tissue))
- **One spare heating filament (FB255B)**
- **Warranty registration**
- **Sutter Instrument Product Catalog**
- **P-1000 & P-97 Pipette Cookbook**
- **Glass Stop**
- **BX-10 Pipette Storage Box**
- **Parameter Guide “cheat sheet” card**

The Model P-97 micropipette puller is shipped to you in a custom box with foam inserts.. Please save shipping materials for future use. Should it ever be necessary to ship the puller to another location, the same packaging should be used to prevent damage to the instrument. Additional packing material may be purchased from Sutter Instrument Company.

IMPORTANT: Improper packaging is a form of abuse and, as such, can be responsible for voiding the warranty where shipping damage is sustained because of such packing.

2.2 Setting Up

2.2.1 Line Power (Mains)

The power cord provided with the P-97 connects to the Power Entry Module located on the back of the unit (see diagram below). This Module also includes the Line Fuse.

* Unless specified otherwise, the P-97 is shipped equipped with, and configured for, a 2.5mm box heating filament.

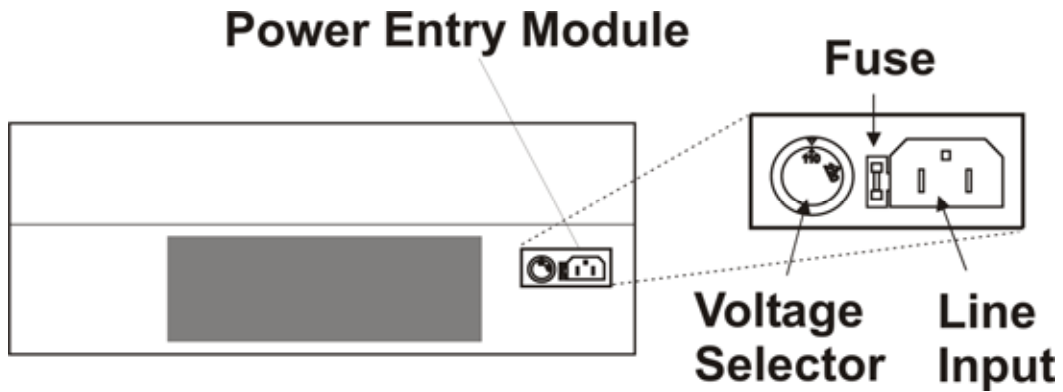

Figure 2-1. P-97 Cabinet (rear view), showing power entry module.

Make certain that the Power Switch located on the left end of the P-97 cabinet is turned OFF.

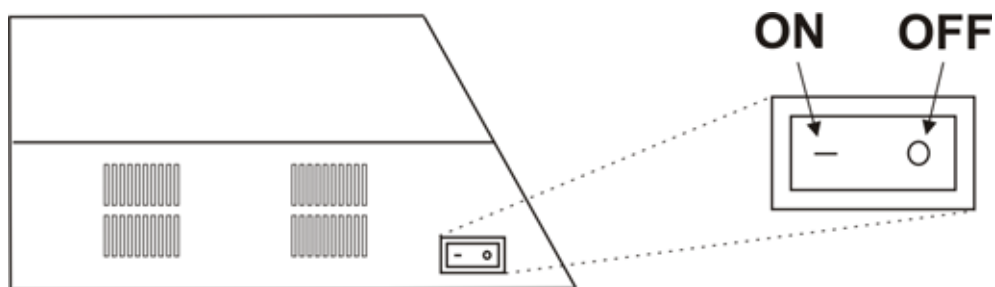

Figure 2-2. P-97 Cabinet (end view, left), showing power switch.

Plug the power cord provided with the P-97 into the Line Input socket on the Power Entry Module and then to a power source of the appropriate voltage and frequency.

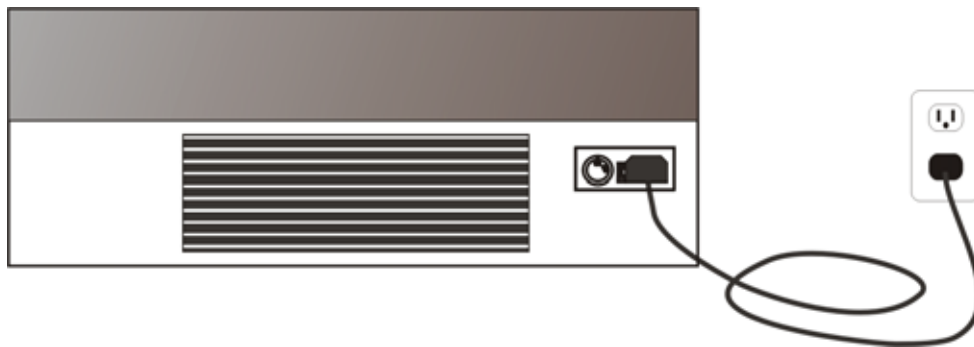

Figure 2-3. Power connection.

3. OPERATING INSTRUCTIONS

3.1 First Time Use

While we realize that most new users of the P-97 are anxious to start pulling useable pipettes right away, we cannot over-state the importance of taking a few moments to review the manual in order to understand how the puller works. Many a heating filament has been destroyed with first use because the user did not understand the relationship between the programmable heat settings and the filament installed in the puller. If you absolutely must use the puller before reading through the manual, the following instructions are provided to help you get going and keep you from vaporizing your heating filament.

1. Make certain that the P-97 is plugged into the power outlet of the correct voltage and frequency.
2. Remove the rubber bands holding the puller bars together.
3. Turn Power switch on left side of cabinet ON.
4. Press < 0 > followed by < ENTR > on the keypad to view Program 0. The cursor will be flashing on the HEAT parameter.
5. Inspect the parameter values displayed for Program 0. Program 0 should display the factory-installed values listed on the enclosed program sheet. If the parameter settings vary, write down the values displayed and then re-enter the program sheet.

CAUTION: *The program HEAT value should not exceed the listed RAMP TEST value by more than 10 units.*

6. Load a piece of the supplied sample glass into puller as follows:

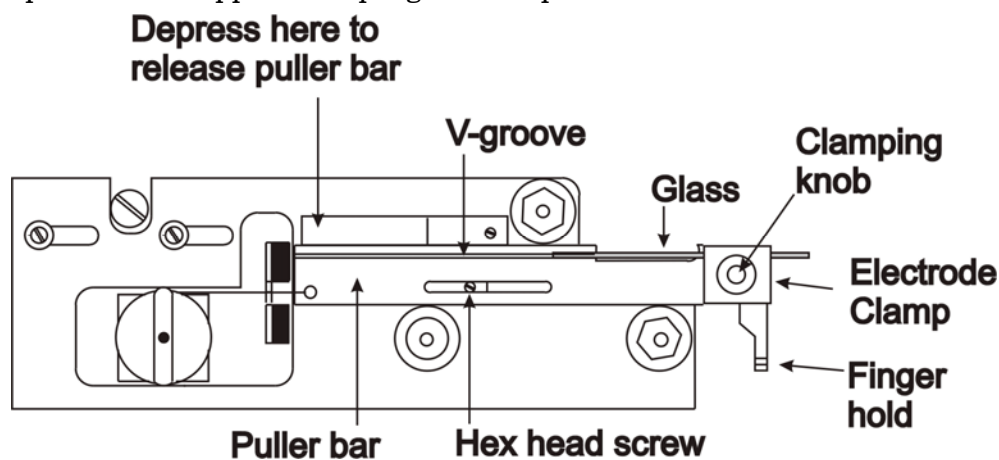

Figure 3-1. Loading a piece of glass.

- a. Loosen both clamping knobs about one complete rotation to avoid breaking the glass as it passes under each electrode clamp.
- b. Place glass in V-groove in puller bar, slide it beyond the clamp about two centimeters and tighten the clamping knob.
- c. Depress the spring stop on each puller bar to release them from their catch position.

- d. Pull both bars towards each other using the finger holds. Hold the puller bars in position using the thumb and index finger of one hand. The hex head screw should be touching the end of the slot in both puller bars.
 - e. Loosen both clamping knobs and carefully slide the glass through the holes in the side of the heater chamber and into V-groove of opposite puller bar.
 - f. Tighten down both clamping knobs.
7. Press the < **PULL** > key on the keypad. The heating filament should turn on and the glass should separate in less than 10 seconds.
 8. Loosen the clamping knobs and remove the pipettes from the puller bars.

Unless otherwise stated on your program sheet, Program 0 is factory pre-programmed to pull a micropipette (tip diameter less than 0.1 μm) from 1.0mm x 0.5mm borosilicate glass. Program 1 is factory pre-programmed to pull a patch type pipette using 1 x 0.5 mm glass to make a tip diameter of about 1 μm . To try the patch pipette program (#1):

1. Press RESET to exit Program 0
2. Press < 1 > followed by < **ENTR** > to enter into Program 1.
3. Repeat Steps 4-7 above.

3.2 Programs

3.2.1 Program Structure

The resulting size and shape of a micropipette made using the P-97 is determined by the parameter values that are programmed by the user. One hundred (100) separate programs can be saved for future use. Each program is structured as follows:

Program	Consists of one or more Lines, each of which represents a pull cycle. When a program is run, all lines within the program are sequentially executed, beginning with Line 1. As a line is executed, the capillary glass inserted in the instrument is “pulled.” A program can be up to 8 lines/cycles in length.
Cycle	A Cycle consists of five programmable parameters; Heat, Pull, Velocity , either Time or Delay , and Pressure . A Cycle is equivalent to one line of Program code.

3.2.2 Program Line Pull Cycle Parameters

Each of the four programmable parameters in a Cycle is defined below:

HEAT	HEAT controls the level of electrical current supplied to the filament. The HEAT required to melt a piece of glass is a function of the filament installed and the particular glass size and composition. It is important that the HEAT value be set relative to the Ramp Test value as discussed in the Operation Section. Generally, changes to HEAT will be made in
-------------	--

steps of about 5 units since in most cases smaller changes will have little effect.

- PULL**
(Range 0-255) This parameter controls the force of the hard pull. In general, the higher the pull, the smaller the pipette's tip diameter and the longer its taper. Useful changes in PULL strength are 10 units or more to see an effect.
- NOTE: A one-line program containing PULL = 0 and a low VELOCITY setting (15 – 40), looped 2-3 times, can be used for making short patch-type pipettes.
- VELOCITY**
(Range 0-255) The VELOCITY of the glass carriage system is measured as the glass softens and begins to pull apart under a constant load. The increasing velocity of the initial pull is determined by the viscosity of the glass, which in turn is a function of the glass temperature. The adjustable velocity allows for the selection of a precise glass viscosity as the trip point for the hard pull. Useful values for velocity range from 10 to 150, with lower values (15-40) being used for patch pipettes and higher values (50-125) for microinjection pipettes. ..
- VELOCITY = 0 Special Condition (Fire Polish Mode):** If VEL=0 and PULL=0, the HEAT will be on for the duration of the TIME programmed (1 unit equals 10ms). This feature allows you to use the puller to fire polish the resulting patch pipette...
- TIME**
(Range 0-255) Controls the length of time the cooling air is active. This parameter is one of two available modes of cooling. If VEL>0 then one unit of TIME represents 1/2ms. If VEL=0 (when in fire-polish mode), then one unit of TIME represents 10ms.
- TIME = 0 Special Condition:** The air solenoid is disabled when TIME=0 (no active cooling). This allows the pulling of special pipette shapes. Most often used to pull long tube-like shapes such as those used for microperfusion.
- DELAY**
(Range 0-255) A cooling mode that controls the delay time between when the HEAT turns off and when the hard PULL is activated. The air is automatically turned on for 300ms. The higher the DELAY value, the cooler the glass will be when the hard PULL is executed. Thus, increasing the DELAY results in decreased taper length and increased tip diameter. If VEL>0 then one unit of DELAY represents 1 ms. If VEL=0 then one unit represents 10 ms.
- DELAY = 0 Special Condition:** The air solenoid is disabled when DELAY = 0 (no active cooling). This allows the pulling of special pipette shapes. Most often used to pull long tube-like shapes such as those used for aspiration, microperfusion, or holding.

3.2.3 Pull Cycle

A typical pull cycle in a program line is described below:

1. The heat turns on.
1. The filament heats up, the glass softens, and a weak pull draws the glass out until it reaches the programmed velocity.
2. When the programmed velocity has been reached, the heat turns off, and the air turns on to cool the filament and glass.
3. If TIME is greater than 0 (zero), the hard pull (if any) is executed after a short delay and then the air is activated for the specified TIME.

If DELAY is greater than 0 (zero), the air is activated for a short period and then the hard pull is activated after the specified DELAY.

3.2.4 Default Configuration

Unless requesting special programming or setup at the time of purchase, the puller is setup and shipped with the following standard factory configuration:

Table 3-1. Standard factory configuration.

Heating Filament Installed	2.5mm Box (Catalog # FB255B)
Glass used to program puller (sample sent with puller)	1.0mm O.D. x 0.5mm I.D. borosilicate, with filament (Catalog # BF100-50-10)
Factory installed programs (see enclosed program sheet)	0 -Micropipette (tip diameter less than 0.1 μ m) 1 -Patch pipette

In describing the operation of the puller, the above configuration is assumed. If the configuration of your puller differs, the operating instructions still apply but references to specific program settings may not be accurate. Inappropriate settings will generally only affect your ability to control the geometry of the glass micropipette you are trying to fabricate. However, **the heating filament can be destroyed by an excessive value for the HEAT parameter.** We recommend you refrain from executing a program until you have read this section of the manual and have run the Ramp Test described herein.

3.2.5 Selecting a Program (0 to 99)

After applying power to the instrument, a “power on” reset will occur and the display will appear as follows:

WHICH PROGRAM DO YOU WANT? (0-99)
COPYRIGHT SUTTER INSTRUMENT CORP. 1992

Figure 3-2. Power-on display.

The P-97 has the capacity to store 100 programs (0 - 99). On the keypad, press < 0 > followed by < **ENTR** > (factory installed micropipette program) or the number of another program you wish to execute. The display will appear as shown below in **Figure 3-3**

(numerical values may vary). Please refer to the FRONT PANEL chapter and the beginning of this chapter for a full description of the PARAMETERS shown.

```
UNLOCKED   P=500   JAN 18, 1997  2:30 PM
3  1 HEAT=525,PULL=150,VEL.= 75,TIME=250
```

Figure 3-3. P-97 Program display.

To select a different program, Press < **RESET** > to bring up the sign-on prompt then press the number of the desired program (0 to 99) followed by < **ENTR** >.

3.2.6 Viewing a Program (< **NEXT** > / < **LAST** >)

The front panel display limits you to viewing only two adjacent lines of a PROGRAM at one time. When you first select a PROGRAM, the display above will appear. The top line of every program is a header line, which displays the PRESSURE setting, the WRITE PROTECT STATUS and the LAST EDIT DATE. The second line of the display is Line 1 of program.

To view additional lines of the program Press the < **NEXT** > key

To scroll to previous lines Press the < **LAST** > key.

3.2.7 Clearing a Program from Memory (< **CLR** >)

To clear the values of a particular program from memory you can utilize the CLEAR function.

Pressing the < **CLR** > key gives you the following message:

```
DO YOU WISH TO CLEAR ALL VALUES FROM THE
PRESENT CYCLE TO THE END? NO=0 YES=1
```

Figure 3-4. Clear Program Display.

Entering < **1** > will clear the PROGRAM from the line the cursor is on to the end of the PROGRAM. If the cursor is on Line 1, the entire program will be cleared from memory. If the cursor is on Line 2, Line 1 will be preserved, and lines 2-8 will be cleared.

3.2.8 Editing a Program

Select a program number (e.g., 10). If there are already values entered, make sure that this program was not entered by another user of the puller. Unused program areas are usually cleared before a puller is shipped, but occasionally test program values are inadvertently left in memory. We recommend that unused programs be cleared before proceeding.

3.2.8.1 Entering a New Program

After selecting or clearing a program area, the cursor will be blinking at the HEAT parameter on Line 1. To familiarize yourself with program entry, enter the following sample micropipette program:

HEAT	PULL	VELOCITY	TIME
525	80	90	250

Press the series of numbers < 525 > to enter the HEAT value of 525. The cursor will automatically tab over to the PULL parameter.

Enter < 80 > for PULL. The cursor will tab over to the VELOCITY parameter.

Enter < 90 > for VELOCITY. The cursor will remain there, blinking. **Note that when less than three digits are entered, the cursor will not automatically tab to the next field.** You must press < **ENTR** > to enter the value and tab to the next field.

Enter < 250 > for TIME. The cursor will tab to the next field, which is HEAT in Line 2.

3.2.8.2 Editing an Existing Program

To edit the value of a parameter(s) in a particular line, the cursor must be blinking in the field you want to edit. If necessary, press < **NEXT** > or < **LAST** > to scroll to the line you want to change. Press < **ENTR** > to tab the cursor to the field you want to change, and enter the new value. In our example above, to change the value of VELOCITY in Line 1, you first press < **LAST** > to scroll up to Line 1. Then press < **ENTR** > two times to tab over to the VELOCITY field. Note that the values for HEAT and PULL remain unchanged. Enter a new value (e.g., 90); if the value is two digits, you must press < **ENTR** > to enter the value. The cursor will be positioned on Line 1 in the TIME field. To move to Line 2, press < **ENTR** > to “tab” over to the HEAT field in Line 2.

The program values above are only given to demonstrate data entry procedures. Useful program values to pull the pipette that you want will be discussed in the next chapter. In general, inappropriate settings will only affect your ability to control the geometry of the glass micropipette you are trying to fabricate. However, **the heating element can be destroyed by an excessive value for the HEAT parameter. Do not use HEAT settings greater than those found in programs 0 and 1 until you have run the RAMP TEST described in the next section.**

3.3 Software Control Functions

The P-97 has several unique software CONTROL FUNCTIONS that allow you to, among other things, run SELF-TEST procedures, set up some of the PULL CONDITIONS and WRITE-PROTECT your program. These control functions are accessed through the < **CLR** > key. Pressing < **CLR** > gives you the following message:

<p>DO YOU WISH TO CLEAR ALL VALUES FROM THE PRESENT CYCLE TO THE END? NO=0 YES=1</p>

Figure 3-5. Access to control functions.

Entering < **0** > will provide you with access to the following P-97 CONTROL FUNCTIONS:

Table 3-2. Control Functions.

Function #	Function Name	Description
1	RAMP TEST	Run the Ramp Test
2	CHANGE AIR PRESSURE	Set the air pressure for a program
3	AIR MODE	Select active cooling mode (Time or Delay)
4	AIR TIME AT START OF PULL	Dehumidify the heating chamber prior to pulling.
5	AIR TIME AT END OF PULL	Purge chamber at end of pull
6	RESET TIME AND DATE	Set the clock
7	WRITE-PROTECT THE PROGRAM	Lock or unlock the write protection
8	MEMORY TEST	Test the integrity of the RAM

The eight control functions will scroll along the bottom line of the display. Select the desired control function by pressing the corresponding numeric key. Each control function is described in more detail below.

3.3.1 RAMP TEST < 1 >

The HEAT value required to melt your glass is based on the characteristics of the heating filament that is installed and the glass you are using. The RAMP TEST allows you to systematically establish or adjust program HEAT values as a function of the filament/glass combination. This test should be run when using the puller for the first time, before writing or editing a program, whenever you change glass or whenever you change the heating filament.

To run a RAMP TEST:

1. Go into any program. For example, Press <1> and then <ENTR> to select Program 1
2. Press <CLR>
3. Press <0> to not clear parameters
4. Select <1> for RAMP TEST
5. Install glass and press <PULL>

When executed, events in the RAMP TEST take place as follows:

1. The puller increments the HEAT at the rate of 650 milliamps per second, and the filament, after 1-2 minutes, begins to get hot and glows orange in color.
2. The puller bars begin to move apart as the HEAT output begins to soften the glass.
3. The HEAT is turned off when a certain velocity (the value of which is stored in ROM) is achieved.
4. The RAMP TEST value shown on the display is the HEAT value that was required to reach the factory-set RAMP TEST velocity.

To interrupt the RAMP TEST or reset the display press RESET.

Recommendations

Table 3-3. Maximum heat and recommended starting values for different filament shapes.

Filament	Maximum/Recommended	Value(s)
Box	Maximum Program HEAT value(s)	Ramp value + 30 units.
	Recommended starting value	Ramp value.
Trough	Maximum program HEAT value(s)	Ramp value + 35 units.
	Recommended starting value	Ramp value+ 15 units.

Additional guidelines for setting program HEAT values relative to RAMP TEST values are given in the Programming Section of this manual. **HEAT settings over RAMP +35 can damage or burn out the filament.**

3.3.2 CHANGE AIR PRESSURE < 2 >

This control sets the pressure generated by the air compressor during the active cooling phase of the pull cycle. Each time a pull is started the air pressure is corrected before the filament turns on. A value must be entered each time this function is accessed. Changes of less than 10 units will not be noticeable. Air pressure is reported on the program header line.

Range 1 to 999

Default 500

Recommendations

For thick walled glass 500

For thin walled glass 200 to 300

3.3.3 AIR MODE < 3 >

Select between one of two modes of cooling during the active cooling phase of the pull cycle. The mode is reported in the fourth field of each program line.

TIME MODE Controls the length of time the gas is on during the cooling phase. One unit of TIME is equal to 1/2 millisecond (e.g., at a setting of 150 the cooling air will be on for 75 ms).

DELAY MODE Controls the onset of the hard pull. The air is turned on for 300 ms during the cooling phase. One unit of DELAY is equal to one millisecond (e.g., a setting of 100 will delay the onset of the hard pull by 100 ms).

Default **TIME MODE**

Recommendations

Use the TIME MODE for:

- Sharp microelectrodes and patch pipette programs using thin-walled glass.
- Glass <1.5 mm O.D.

Use the DELAY MODE for:

- Transfer of model P-87 puller programs to P-97
- Patch programs using thick-walled glass
- Single and multiple cycle programs
- Glass > 1.2mm O.D.
- Thick-walled glass
- Transfer of model P80-PC puller programs to P-97. x

3.3.4 AIR TIME AT START OF PULL < 4 >

Controls the length of time the humidity control chamber is purged with dehumidified air prior to execution of the pull sequence. The intent of the control is to minimize and stabilize the chamber humidity during the pull sequence. Units are in seconds.

Range 1 to 255 seconds

Default 5 seconds

Recommendations

For humid environments 20 to 30 seconds

3.3.5 AIR TIME AT END OF PULL < 5 >

Controls the length of time the chamber is cooled after completion of the pull and the length of time the end of pull information is displayed. Units are in seconds. The time you enter is actually an offset added to an automatic 3-second chamber cooling cycle [e.g., A setting of 5 would result with 8 seconds of chamber cooling].

Range 0 to 255 seconds

Default 5 seconds

Recommendations

For single cycle programs 5 seconds

For multicycle programs 25 seconds
(to allow additional cooling of the heating clamp assembly)

3.3.6 RESET TIME AND DATE < 6 >

This function allows you to set the system clock. The clock is used to establish the date and time of the last program edit as displayed on the program header line.

3.3.7 WRITE-PROTECT THE PROGRAM < 7 >

Activate (lock) or inactivate (unlock) the WRITE PROTECTION mode. Unlocked mode (0) allows program to be edited. Locked mode (1) prevents program from being edited. The write-protect status is reported on the program header line.

Write Protection (Off by default)

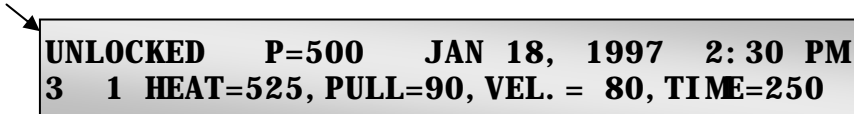

```
UNLOCKED P=500 JAN 18, 1997 2:30 PM
3 1 HEAT=525, PULL=90, VEL. = 80, TIME=250
```

Figure 3-6. Write protection default state.

3.3.8 MEMORY TEST < 8 >

Performs a non-destructive test of the RAM. Press RESET to reset the system after performing this test. On newer versions of P-97 pullers, the Memory Test is no longer a valid test.

3.4 Pulling Pipettes

3.4.1 Procedures

Prior to pulling a pipette for the first time, it is important to establish what HEAT value is appropriate to melt your glass. Before executing a program for the first time, **run the RAMP TEST** as previously described, and note the Ramp value reported. The HEAT settings in the factory-installed programs are typically set at the Ramp value. If your Ramp test value differs from the factory Ramp value, adjust the HEAT in your programs to your Ramp value.

Once you have adjusted the HEAT value relative to the Ramp value, pulling a pipette is very straightforward. Try executing the factory installed programs with the sample glass to become familiar with the pulling process.

1. Load the glass into the puller as described previously in the FIRST TIME USE chapter.
2. Press < 0 > followed by < ENTR > on the keypad to view Program 0.
3. Inspect the parameter values displayed for Program 0. Program 0 should display the factory-installed values listed on the enclosed program sheet. Adjust the HEAT setting to your Ramp value.
4. Press the < PULL > key on the keypad. The heating filament will turn on and the glass should separate within 10 seconds. The display will then report the number of heating cycles and the total time that the heat was on, similar to the following:



```
THE PROGRAM LOOPED 01 TIMES. THE LAST
LINE USED WAS 01, HEAT ON SEC. = 6.05
```

Figure 3-7. Pull Cycle Report.

5. Loosen the clamping knobs and remove the pipettes from the puller bars.

Unless otherwise stated on your program sheet, Program 0 is factory pre-programmed to pull a micropipette (tip diameter less than 0.1 mm) from 1.0mm x 0.5 mm borosilicate glass. It will pull the pipette in one heating cycle or 'loop'. The time reported is very useful for developing programs and will be discussed in the Parameter Adjustment section of this manual.

A unique feature of the P-97 is its capability to loop through a program. This is demonstrated with the multicycle Program 1, which is factory pre-programmed to pull a patch type pipette with a tip diameter of about 2mm. Press RESET to exit Program 0, and then press < 1 > followed by < ENTR > to enter into Program 1. The display for Program 1 should read similar to the following:

```
UNLOCKED   P=500   JAN 18, 1997   2:35 PM
1  1 HEAT=525,PULL= 0,VEL.= 30,DELAY= 1
```

Figure 3-8. Sample program.

Adjust the HEAT in the program to the Ramp value. Load glass into the puller and press **PULL**. The heating filament should cycle on and off repeatedly. When the pull is complete, the display should read similar to the following:

```
THE PROGRAM LOOPED 03 TIMES. THE LAST
LINE USED WAS 01, HEAT ON SEC. = 12.3
```

Figure 3-9. Pull cycle report (multiple-loops)..

After the heat turns on in line 01, the glass heats up and draws apart until it reaches a VELOCITY of 30, at which point the heat turns off and the cooling air turns on. The puller is “aware” of the fact that the glass has not separated yet, and will go back to line 01 of the program and try again; in effect, it begins ‘looping’. It will continue to do so until the glass separates. This looping capability is particularly useful for fabricating patch pipettes, which require multiple heating cycles to form the characteristic stubby geometry.

3.4.2 Notes on Program Operation

There is always the possibility that the puller will be given a set of values that ‘stall’ its operation. For example, the HEAT value has not been set high enough to melt the glass, thus the glass cannot be pulled and no VELOCITY can be achieved. If it appears that a situation of this type has arisen, press the STOP key. This action aborts program execution and allows editing to take place.

All programs entered into memory (maximum of 100) remain there even after the power is turned off or the RESET switch is toggled. A special memory ‘chip’ that carries its own battery back up will retain stored information for as long as ten years without power being applied to the instrument. Miracle that this is, it is strongly suggested that you keep a written record of your programs in case of unexpected difficulties.

3.5 Parameter Adjustment

3.5.1 General Information

Micropipette and microinjection needle programs are sufficiently different from patch pipette programs that the following information on parameter adjustments has been divided into three sections: **Micropipette/microinjection needle fabrication**, **Patch pipette fabrication** and **Technical Tips**. Even if your research only requires one type of pipette, we recommend that you read all three sections for full appreciation of the capabilities of the puller. Please note that the programs referred to in the following text are not necessarily meant to pull functional pipettes, but are intended as an exercise to help develop an understanding of the

programming process. Unless otherwise stated, parameter adjustments assume that the puller is in the **TIME** mode of active cooling (see Software Control Functions).

3.5.2 Micropipette/Microinjection Needle Fabrication

Consider the following programs using a 2.5 mm-box filament:

Sharp Microelectrode Program using 1.0 x 0.5 mm borosilicate glass

HEAT	PULL	VELOCITY	TIME	PRESSURE
Ramp	150	75	250	500

Microinjection Pipette Program using 1.0 x 0.78 mm borosilicate glass

HEAT	PULL	VELOCITY	DELAY	PRESSURE
Ramp	60	80	90	200

3.5.2.1 HEAT

The HEAT setting will affect the length and tip size of the pipette. Generally, higher HEAT settings tend to give longer and finer tips. For trough filaments, the recommended starting HEAT value is the ramp test value plus 15 units. For box filaments, the recommended starting HEAT value is the ramp test value. The program listed above will typically have heat on for 5 to 8 seconds after the <PULL> key is pressed. If the time is longer than eight seconds and you are trying to pull a fine micropipette, increase the HEAT in 5 unit increments until the pull takes place in less than eight seconds. If the pull occurs in less than three seconds, decrease the HEAT until the pull takes place in 4 to 8 seconds. For the best micropipette reproducibility with the finest tips, you should select a HEAT value that melts the glass in 5 to 6 seconds. For microinjection pipettes, select a HEAT value that melts the glass in about 7 seconds or longer.

3.5.2.2 PULL Strength

Low values of PULL strength in the range of 50 to 75 will give larger tips appropriate for injection needles, while 80 to 150 give smaller tips appropriate for sharp microelectrodes. The PULL strength can be set to any value desired with no danger of damaging the instrument.

3.5.2.3 VELOCITY (Trip Point)

The VELOCITY value determines the point at which the heat is turned off. VELOCITY reflects the speed at which the two puller bars are moving during the weak pull. The lower the VELOCITY value, the slower the speed of the bars when the trip point occurs. Although VELOCITY can safely be set to any value from 1-255, all values over a maximal trip point (usually about 150) will produce equivalent results. As the pull progresses, the speed of the puller bars, as measured by the velocity transducer, reaches a point where further increases in the VELOCITY trip point will not change the time point at which the heat is turned off. VELOCITY is typically set between 80 to 90 for microelectrodes or 50 to 80 for microinjection pipettes.

In a multiple cycle program, it is possible for the glass to separate before the trip velocity is attained. Thus, the glass is subjected to heating as it separates. Such an occurrence can lead to difficulties in forming tips as well as lack of reproducibility. If you are using a one-line, looping program, try decreasing the VELOCITY a few units at a time. If your program is a

multi-line program, decrease the VELOCITY in the next to last line of the program. Decreasing the VELOCITY will increase the amount of glass left in the last cycle of the program, thus allowing the glass to attain the trip velocity before separating.

3.5.2.4 TIME Mode (Cooling)

The TIME parameter controls the length of time the cooling air is active (one unit of TIME is equivalent to 0.5 ms). In order to produce effective cooling, the air must be supplied to the filament and glass during the time the tip is being formed. When pulling sharp electrodes, the hard pull lasts several tens of milliseconds. Because of this fact, increasing cooling TIME values beyond a certain range (typically 200 to 250) will have no effect. Values of TIME under 200 will cool the glass less as the tip is being formed and lead to a longer taper. However, once TIME values become too short (values in the range 110 to 130) cooling becomes ineffective. The glass will not form a tip and instead forms a wispy fiber. The very finest tips for a given PULL and HEAT will be formed at an air setting of about 5 units higher than the lowest TIME value that forms a tip. Because of this quite narrow working range of usable TIME values for making micropipettes, it is not recommended to vary cooling, and therefore electrode tip length, by adjusting TIME. Adjusting the cooling air pressure and/or switching to the DELAY mode of active cooling are both more effective means of controlling tip length (see below).

3.5.2.5 Delay Mode (Cooling)

In TIME mode, especially when using larger and or thicker walled glass, active cooling may not be sufficient to produce short pipette tapers. This may even be true at increased PRESSURE settings (i.e. >500). In this case, it is recommended that the DELAY mode of active cooling be used. The method for changing to the DELAY mode is described under “Software Control Functions” and a brief description of the two modes of cooling is given in “Programs.”

After switching to DELAY mode, one then has direct control over the delay between turning the heating filament off and initiating of the hard pull. Because the cooling air is turned on when the filament is turned off, increasing DELAY profoundly increases glass cooling before and during the hard pull.

With a range of control over the degree of pipette cooling one can control the rapidity of pipette taper. Higher DELAY values (longer delay) increase cooling and form a pipette with a more rapid taper (shorter shank) while lower DELAY values (shorter delay) decrease cooling and form a pipette with a more gradual taper (longer shank). Fortunately, cooling induced changes in pipette taper generally occur with little effect on tip size. This is quite valuable as the resistance of pipettes is a strong function of the length of the taper. By making a pipette with a sharper taper, one can often decrease pipette resistance significantly without changing the size of the pipette tip. Furthermore, the ability to control tip length is invaluable for experiments where long tips are necessary for penetration into deep tissues or where short stiff tips are necessary for adequate beveling.

Minimum and maximum useable values of DELAY can be expected; their exact values are dependent on glass thickness and diameter. If DELAY is too short, the glass will not cool sufficiently to form a tip and a long wispy fiber of glass will be formed. Values under 40 units tend to be ineffective. At some maximal value of DELAY, the glass may be cooled too much to separate during the hard pull. Under these conditions, the puller will typically execute multiple cycles in order to separate the glass and the glass may break at a large tip diameter.

Maximum usable values of DELAY will be dependent on glass dimensions but are expected to be near 200 (100ms of delay).

3.5.2.6 PRESSURE Adjustment

The pressure setting controls the pressure of the cooling air delivered to the filament. The higher the pressure, the shorter the pipette taper will be. Because thin walled glass cools more rapidly than thick walled glass, the recommended values are ≤ 300 for thin walled tubing and 500 for thick walled or standard walled tubing. By varying PRESSURE around these values, the user can control pipette tip length over a moderate range.

3.5.2.7 Filament Width

Further control over pipette tip length can be accomplished by varying filament width. Longer tips can be formed by using wider filaments and conversely shorter tips can be formed by using narrower filaments.

3.5.3 Patch Pipette Fabrication

Pipettes used for the electrophysiological recording technique of “patch clamping” are characterized by a short, stubby shank and relatively large diameter tips (> 0.7 mm). Programs that can fabricate a pipette with these characteristics generally differ from programs for micropipettes in three ways:

The trip velocity is lower.

Hard pull is not activated (PULL = 0).

More than one heating cycle is used.

The P-97 can be used very effectively for this type of processing. The following general information will familiarize you with the effect of adjusting each of the pull cycle parameters in a typical patch pipette program. Following this general information are step-by-step instructions intended to help you establish a stable program to pull patch type pipettes and should be followed in the order described.

Consider the following sample patch program for 1.5 mm O.D. by 0.86 mm I.D. borosilicate glass using a 2.5 x 2.5 mm Box filament:

HEAT	PULL	VELOCITY	DELAY	PRESSURE
Ramp	0	23	1	500

A program sequentially executes each line of code, then loops back to the start, and begins again until the glass separates. A single line program such as this may execute two to four times before the glass separates.

3.5.3.1 HEAT

The actual HEAT value used should be sufficiently high to allow the glass to melt in the first cycle in 5 to 15 seconds. Using a higher HEAT that melts the glass in less than 5 seconds will cause no problem in the first heating cycle, but may heat the glass so much in subsequent heating cycles, that the air cooling will be less effective.

3.5.3.2 PULL Strength

A constant gravitational pull on the puller bars that can be felt when loading the glass. This pull is usually adequate to form relatively small tipped pipettes (0.5 mm). Eliminating the hard pull from the program (PULL=0) is recommended for most patch pipettes. If smaller tips are required, a moderate PULL (25-50) may be used in the last line of a multi-line program (see below).

3.5.3.3 VELOCITY (Trip Point)

VELOCITY determines the point at which the heat is turned off. If the value is too high, the glass will separate after the third heat cycle. As the VELOCITY is decreased, the amount of glass drawn-out in a given cycle will also decrease, and more cycles will be required to form a tip. The greater the number of cycles, the larger the pipette's tip will be and the shorter it's taper. However, too many cycles can lead to variability. Generally, it is advisable to keep the number of heating cycles to 5 or less.

3.5.3.4 Cooling

TIME Mode: When using thin-walled glass to make patch pipettes (slice patch), it is advisable to keep the TIME between 200 and 250 to maximize the cooling of the glass.

DELAY Mode: The DELAY mode (DELAY = 1) is recommended when pulling a patch pipette and using thick-walled glass, a box filament, and/or needing short-tapered pipettes. The DELAY mode provides a set 300 milliseconds of cooling.

3.5.3.5 PRESSURE

The recommended pressure setting when using thick walled glass is 500 or greater. For thin walled glass, the recommended range is 200 to 500.

3.5.4 Step-by-Step Patch Pipette Programming

Run a Ramp Test with the glass you intend to use for your particular application. Refer to the manual if you need to review the Ramp Test procedure. When you know the Ramp value (R), use it in the following program.

1. Program one line of code as follows:

Filament Type	HEAT	PULL	VELOCITY	TIME/DELAY
Box	Ramp	0	*30	DELAY=1
Trough	Ramp + 15	0	*50	TIME=150

* The VELOCITY value will need to be manipulated.

PRESSURE should be set to 500 for thick walled glass and 300 for thin walled glass.

2. Insert your glass and execute the above program. The program should "loop" a multiple number of times (i.e. the same line will be repeatedly executed). The display will report the number of loops at the end of the pull sequence. This "looping" is the key to forming patch pipettes. For thin walled glass, 2 to 3 loops are typically all that is required. For thick walled glass, 4 to 5 loops are typically required.
3. Increase the VELOCITY in one unit increments for thick-walled glass and three unit increments for thin-walled glass. Pull a pipette after each adjustment. Note the change in

the number of loops and note the geometry of the pipette (viewed with microscope). As the VELOCITY **increases**, the number of loops **decreases**.

4. Repeat step (3) only this time decrease the VELOCITY. As the VELOCITY **decreases**, the number of loops **increases**.
5. By adjusting the VELOCITY as described, establish the number of loops required to approximately form a pipette with the characteristics you desire. Set the VELOCITY value in your program to the number that falls midway between the values required to loop one more and one less times than the desired number. This is called the “mid-point velocity”. For example, while experimenting with VELOCITY values, you find that when the glass separates after 3 loops the resulting pipette looks pretty reasonable. Let Y be equal to the VELOCITY value that results with the glass separating after four loops. Let Z be equal to the VELOCITY value that results with the glass separating after two loops. Set your program VELOCITY, to a value midway between Y and Z. This value will be a very stable VELOCITY value and will provide you with the most reproducible results.
6. The one line program just established may be sufficient for your application. However, changes made in a one-line program are amplified throughout the cycle, potentially producing gross changes in the pipette. If you need to make fine adjustments to the pipette geometry, then you should use a multi-line program. The multi-line program is based on the one line program just established. It is developed as follows:
7. Write your one-line, looping program out into an equivalent multi-line program with the number of lines equal to the number of loops. For example, a one line, 4 loop program with the following values:

	HEAT	PULL	VELOCITY	DELAY
Loops 4 times	525	0	23	1

The program could be rewritten into an equivalent 4 line program:

	HEAT	PULL	VELOCITY	DELAY
Line 1	525	0	23	1
Line 2	525	0	23	1
Line 3	525	0	23	1
Line 4	525	0	23	1

8. Now, you can make adjustments to the last or next to last line to fine-tune the program and the resulting pipette.
9. Recommended changes to fine tune the multi-line program:
 - For larger diameter tips: Decrease HEAT in **last line**.
 - For smaller diameter tips: Increase or decrease VELOCITY in **next to last line** by 2 to 3 units, or increase/decrease VELOCITY in **last line** by 2 to 3 units, or add a small amount of PULL (10 to 20) to **last line**.

3.5.5 Technical Tips for Pulling Micropipettes

3.5.5.1 Regulating the Time it takes to pull a Sharp Pipette

HEAT. If the pull takes longer than eight seconds while using 1.0mm O.D. tubing to pull a fine- micropipette, increase the HEAT. To do this in a methodical fashion, increase the HEAT value in five unit increments, each time monitoring pull time until the pull takes place in less than eight seconds.

If the pull occurs in less than three seconds after you start, decrease the HEAT value in a similar fashion.

For 2mm O.D. tubing, the pull should occur between 10 and 15 seconds after the start. Make corrections as outlined above for smaller tubing.

3.5.5.1.1 Pipette Position

The position of the glass within the filament will also affect the time it takes to pull a pipette. When using a trough filament the glass should be about 0.5mm above the bottom of the filament and centered front to back. In the case of a box filament the glass should be in the center of the filament. Filament positioning is covered in the next section of this manual “Heating Filaments”.

3.5.5.2 Regulating the Length and Tip Size of a Sharp Pipette

HEAT. Higher HEAT settings will give longer and finer tips. A HEAT value equal to the Ramp Test value plus 10 units will generally give a very fine tip.

NOTE: At high HEAT settings (filament white-hot), the filament life is greatly reduced. Initially, use a setting equal to the ramp value plus 5: electrode length is controlled by air pressure adjustments. If this is insufficient, a wider or more narrow filament can be installed.

3.5.5.2.1 Filament Width

Filaments narrower than 2mm cannot form as fine a tip as the wider filaments. The tip size will decrease with increasing filament width until a width of 3mm is reached. Increasing the filament width beyond 3mm will produce longer and more gradual tapers (which may penetrate better in some cases). The tip, however, will not be any smaller.

3.5.5.2.2 Air Flow

In general, electrodes will not be formed if the air pressure is set too high. It is thus recommended that the pressure be set to standardized values of 500 for thick walled glass and 300 for thin walled tubing. However, as outlined above, under **Micropipette/microinjection needle fabrication**, the length of pipette tips can be controlled by varying air pressure. Furthermore, when making patch pipettes, if increasing TIME to its maximal setting of 255 does not provide enough cooling to produce tips with a short enough taper, then using the delay mode or increasing pressure above the standard values may be warranted.

3.5.5.2.3 DELAY Mode of Active Cooling

As discussed previously this manual, switching from the TIME to the DELAY mode of active cooling may give more precise, and a wider range, of control over the length (or taper) of a sharp pipette tip. The delay mode is often employed when using thick walled glass or for programs designed for the fabrication of pronuclear injection needles.

3.5.6 Fire Polishing

The P-97 micropipette puller allows you to perform light to moderate fire polishing of pipette tips but does not have a provision for visualizing the pipette tip during the heating process. The extent of the heating required to attain the desired degree of polishing must be empirically established.

What distinguishes a program for polishing from other programs used to pull pipettes is the use of a Velocity value of 0 (zero). To program the instrument for the fire-polishing mode, try entering a program as follows:

HEAT	PULL	VELOCITY	TIME
Ramp - 50	0	0	250

Pressure does not matter because the air supply is never activated in this mode.

When executed, this program will behave as follows: the Heat will turn on for the duration set by Time. Each Time unit is equivalent to 10 msec. Therefore, in the above program, the Heat will turn on for 2.5 seconds.

The procedure for polishing is as follows:

1. Pull a pair of pipettes with the desired pulling program. After the pipettes have been pulled, keep them clamped in the puller bars.
2. Reset the puller and select your polishing program (as above).
3. Manually push the puller bar (with the installed pipette) back towards the filament, and use the Fire Polish Spacer block described next. Using the adjusting screw on the top of the spacer, positioning the tip of the pipette just inside the edge of the filament.
4. Press Pull and the filament will heat up for 2.5 seconds, exerting a polish on the end of the pipette.

How much polishing occurs will be a function of the Heat value and the duration of that Heat as determined by the Time value. You may need to execute the program multiple times to achieve an appropriate polish. Experiment to determine how much Heat and Time are necessary for the degree of polishing required.

The most difficult part of this procedure is manually positioning each pipette back into the filament at the same relative position each time. The Fire Polishing Spacer allows you to consistently reposition the pipette within the filament. The T-shaped aluminum Spacer has an adjustable setscrew.

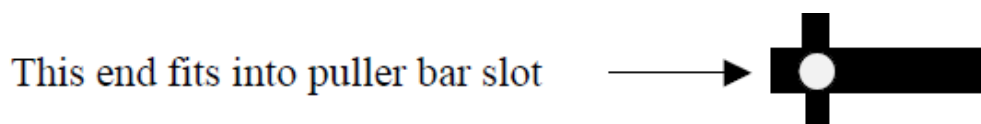

Figure 3-10. Side view of fire polishing spacer.

The Spacer/screw combination fits into the slot in the puller bar and fixes the puller bar position. You adjust the screw position to set the position of the puller bar (and thus the pipette tip). The more extended the screw is, the closer the pipette tip will be to the heating filament.

When you have finished polishing the pipette, remove the Spacer from the puller bar.

LEFT PULLER BAR

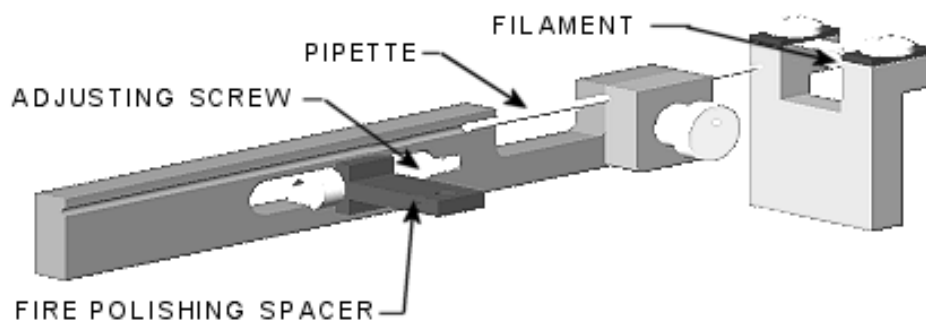

Figure 3-11. Fire Polish Spacer in Puller Bar.

3.6 Heating Filaments

3.6.1 General Information

The pipette programs that you ultimately develop will largely depend on the type of heating filament installed in the puller and the glass that you use. Depending on your research application, there may be an optimum filament/glass combination that differs from the configuration with which the puller is currently set up. After reading through the following material, if you have questions about which filament to use for your application, contact our technical support staff.

3.6.2 Filament Positioning and Aligning

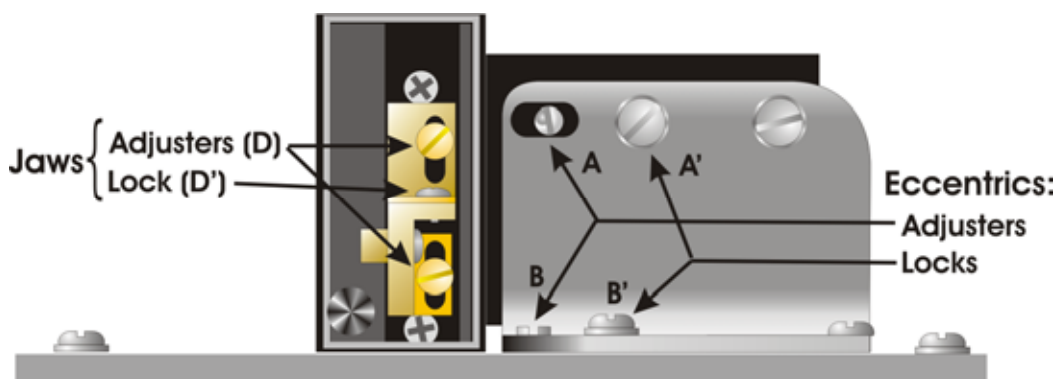

Figure 3-12. Filament alignment.

Adjust the filament position using the two eccentric chrome screws located on the silver or black angle piece that holds the filament assembly (A and B in **Figure 3-1**). First loosen the two locking screws (A' and B' in **Figure 3-1**) and then the filament can be moved in relation to the glass tubing by turning the appropriate eccentric chrome screw (A or B in **Figure 3-1**). See the Filament Replacement section of the Maintenance Chapter for a full description of this adjustment.

3.6.3 Box Filament

The box-shaped heating filament is recommended as the standard for most applications. The box filament heats the glass in a more symmetrical fashion than other filaments (such as the trough filament), so that the pipettes produced tend to be shorter and more straight and concentric. It delivers more heat to the glass resulting in faster heating without the necessity of increasing the temperature of the filament.

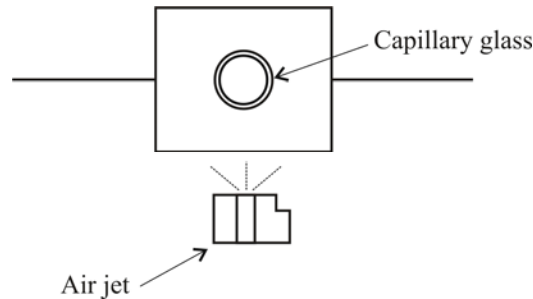

Figure 3-13. End view of box filament and glass.

Note: The Ramp Test value with a box filament will be higher than that with the trough filament, thus program HEAT values will be correspondingly higher in order to reach similar operating temperatures.

Box filaments are recommended for the following micropipettes:

Patch pipettes using thick-walled glass

Microelectrodes used for slice preparations where long, parallel walls would aid penetration

Microinjection needles for transgenic research

Microdissection tools

Thick or multi-barreled glass

Aluminosilicate glass

The box filament has two primary limitations.

First, it requires more current to heat to a given temperature than the same size trough filament. Thus, it is possible to use wider trough filaments without exceeding the maximum current capacity of the puller.

Second, the box configuration reduces the cooling effect of the air jet. For this reason, velocity settings often lowered.

3.6.3.1 Positioning

When using a box filament, the glass tubing should be centered vertically and horizontally (**Figure 3-12**). See section 3.6.2 for adjustments and alignment.

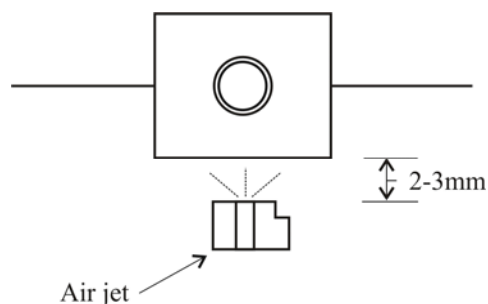

Figure 3-14. Box filament positioning.

3.6.3.2 Geometry

The box size you select should be approximately 0.5 to 1.5 mm larger than the outside diameter of the glass you are using. The width of the filament will depend on the research application. A good general-purpose box filament is the 2.5mm wide, 2.5mm high, and 2.5mm deep filament (**FB255B**). Special box filaments made to accommodate larger diameter glass or special pulling applications are available upon request.

Table 3-4. Box filament sizes.

Filament	Description	Glass O.D.
FB215B	2mm square x 1.5mm wide	1.0mm
FB220B	2mm square x 2.0mm wide	1.0mm
FB230B	2mm square x 3.0mm wide	1.0mm
FB255B (Standard)	2.5mm square x 2.5mm wide	≤ 2.0mm
FB245B	2.5mm square x 4.5mm wide	≤ 2.0mm
FB315B	3mm square x 1.5mm wide	≤ 1.5mm
FB320B	3mm square x 2.0mm wide	≤ 1.5mm
FB330B	3mm square x 3.0mm wide	≤ 2.0mm or 2-3 barrels

3.6.4 Trough Filament

The trough filament is a general-purpose filament. It is recommended for standard or thin wall glasses used for patch pipette fabrication, sharp electrodes with long tapers, and some types of microinjection needles.

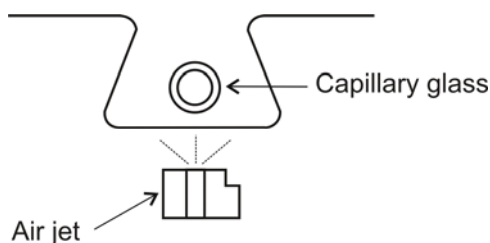

Figure 3-15. End view of trough filament and glass.

Note: The Ramp Test value with a trough filament will be lower than that with the box filament, thus program HEAT values will be correspondingly lower in order to reach similar operating temperatures.

3.6.4.1 Positioning

When using the trough filaments, the glass tubing should be positioned just above the bottom of the filament (approx. 0.5mm), and centered between the two sides (**Figure 3-15**). See section 3.6.2 for adjustments and alignment.

3.6.4.2 Geometry

The geometry of the trough filament is an important factor for proper heat application to the glass. Replacement trough filaments should have a profile similar to that illustrated in **Figure 3-15**, where the distance between the top corners (distance A) is approximately 2/3 the length of the bottom of the filament. This geometry will provide improved heat distribution to the top of the glass tubing. When replacing a filament, check the new filament geometry. If it differs appreciably from the ideal, you can easily modify it by grasping the bottom corners with non-serrated forceps and gently pushing on the horizontal ‘wings’.

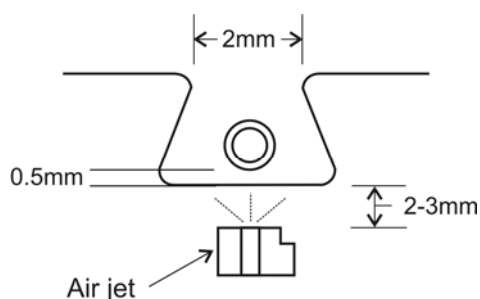

Figure 3-16. Trough filament positioning.

The trough filament you select depends upon the length of the taper that you want. Wider filaments for special purposes are available upon request.

Table 3-5. Trough filament sizes.

Filament	Description
FT315B	1.5mm wide trough
FT320B	2mm wide trough
FT330B (standard)	3mm wide trough
FT345B	4.5mm wide trough

4. MAINTENANCE

4.1 Cleaning

Routinely clean the exterior and the base plate of the unit by wiping them with a dry cloth to remove dust and fine pieces of glass. Avoid contact with the filament.

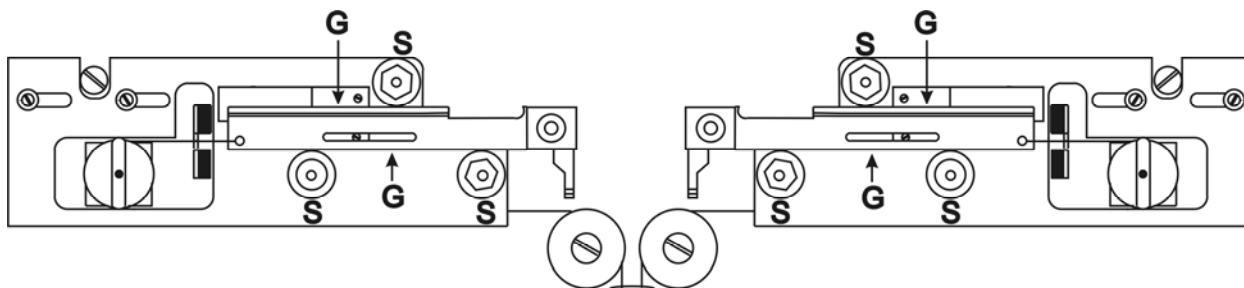

Figure 4-1. V-Groove bearings and puller bars.

Occasionally the V-groove bearings (**S in Figure 4-1**) and the edges of the pull bars that slide in their grooves (**G in Figure 4-1**) must be cleaned to maintain reproducibility from pull to pull. This should be done using a dry cotton swab.

⚠ CAUTION: DO NOT lubricate any components of the P-97!

NOTE: See Sutter Instrument's YouTube video "Installing a Filament" (<https://www.youtube.com/watch?v=cCsJsIZlzLw>).

4.2 Heating Filament Replacement

4.2.1 Filament Replacement (Step by Step)

1. Remove the chamber that encloses the heating filament (remove the black thumbscrew at the lower left corner of the Plexiglas cover plate and pull the chamber straight off).
2. Loosen the two clamp screws (**D' in Figure 4-2, only one shown**) that hold the filament in place, and then slide out the old filament.
3. Slip in a new filament, center it over the air jet, and then retighten the two clamp screws.
4. Reinstall the chamber that encloses the heating filament and retighten the black thumbscrews (lower left corner of the Plexiglass cover plate).

4.2.2 Air jet Position

The air jet should be from 2 to 3 mm below the center of the filament. If it not within this specification, then loosen the screw holding the air jet in place and reposition it.

4.2.3 Positioning the Filament in Relation to the Glass Capillary

The correct position of the glass capillary in each of the two filament types is shown above in the Heating Filament section. This positioning is critical to achieving the desired pipette's tip

size and shape, and will almost certainly require adjustment after replacing a filament. To make this adjustment:

1. Carefully slide the glass to be used along the V-groove in the puller bar, and see where it is positioned relative to the filament.
2. Locate the aluminum angle plate to the right of the filament assembly and behind the right puller bar. Two chrome eccentric screws (**A and B in Figure 4-2**) in slots are mounted on this bracket, one located on the vertical face of the bracket and one on the horizontal face. Identify the flathead locking screws to the right of each chrome screw.

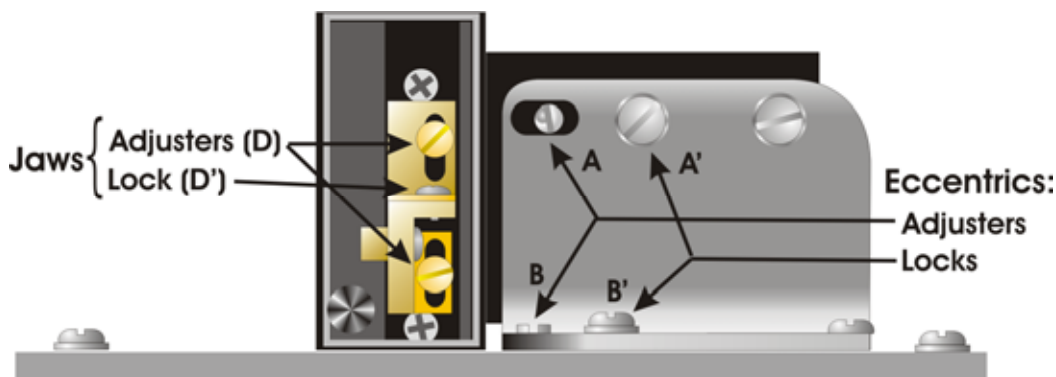

Figure 4-2. Filament alignment.

3. Loosen the locking screws (**A' and B'**)
4. Turn the eccentric chrome screw (**A**) on the vertical face to adjust the vertical position of the filament and the eccentric chrome screw (**B**) on the horizontal face to adjust the front-to-back position of the filament.
5. Tighten the locking screws (**A' and B'**).
6. If the vertical excursion available with the vertical cam screw is not enough to center the glass, you will need to reposition the upper and lower heater jaw assemblies by first loosening the brass screws holding the jaws to the black nylon (**D**). Reposition the jaws then retighten the brass screws and re-position the air jet.

Testing the Position: After positioning the filament it is important to determine if the filament is centered left-to-right over the air jet.

Run a RAMP TEST with your glass and the new filament. If you are unclear as to how to run the ramp test, please review the Software Control Functions section of this manual.

Install a one-line program similar to the following:

HEAT	PULL	VELOCITY	TIME	PRESSURE
Ramp	70	70	250	500

This program is only being used to test pipette length. Pull a pair of pipettes. Remove the pipettes from the puller bars and hold them side by side as shown in the figure below. If the shanks of the pipettes vary in length, this is an indication that the filament is not centered left to right relative to the air jet, thus one pipette is “seeing” more cooling than the other. Loosen the filament clamping screws and move the filament very slightly towards the side

that produced the shorter pipette. Then tighten up the clamps and try another pull. You may have to go through several iterations before you get it centered properly.

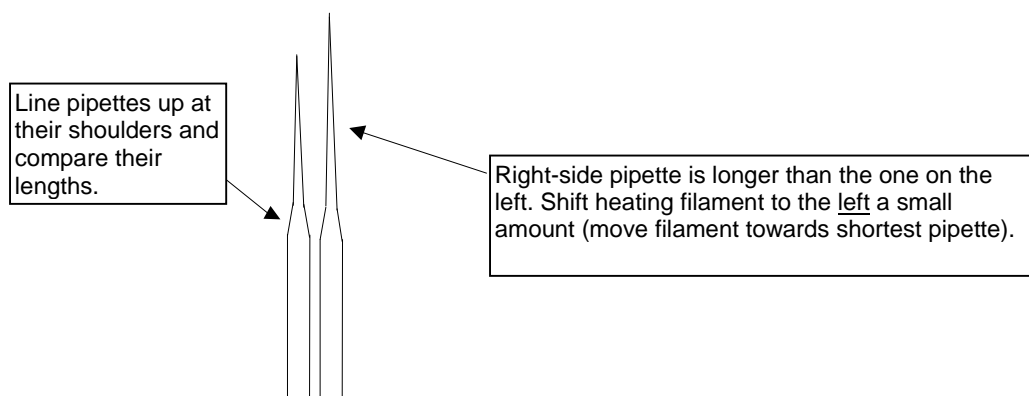

Figure 4-3. Micropipette shapes.

4.3 Pulley Adjustment

NOTE: Contacting Sutter Instrument Technical Support is highly recommended before performing a pulley adjustment.

The position of the two pulleys (**F in Figure 4-4A**) which guide the cables from the solenoid (**not shown**) to the puller bars (**G in Figure 4-4A**) is adjustable. The pulley position controls the tension of the cables. A difference between the tensions of the two cables can cause problems with pipette reproducibility and/or a disparity between the taper lengths of the pair of pulled pipettes (as illustrated in **Figure 4-4**). Taper length inequality is generally caused by the air jet not being aimed at the center of the filament, so to avoid unnecessary adjustments to the pulleys, be certain that the filament and air jet are correctly positioned before proceeding.

The pulley adjustment is made by moving one or both of the pulleys to equalize the tension on the two cables. There are two sets of stops in the system; the stops in the carrier slots against which the carriers rest (**M in Figure 4-4A**), and a stop to prevent the solenoid from being pulled out of its housing (**not shown**). The adjustment of the pulleys must be made so that the carriers will still come up against their stops while the solenoid is not against its stop. The two cables should not be under high tension when the carriers are against their stops (the position they would be in just before pulling an electrode).

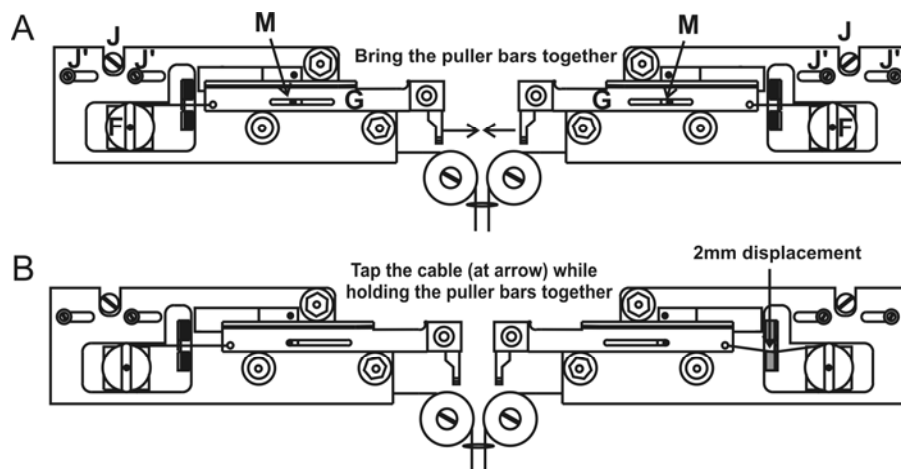

Figure 4-4. Pulley Adjustment.

Holding the puller bars together with one hand, you should be able to press on either cable between the carrier and the pulley and feel about 2mm of deflection (**Figure 4-4B**) before the solenoid hits its stop. You will hear a clamping noise inside the chassis when the solenoid hits the stop. If the deflection is more or less, the pulley position should be changed. This is done by loosening the two screws above the pulley (**J' in Figure 4-4A**) and turning the chrome eccentric screws (**J in Figure 4-4A**) to move the pulley in small increments until the two cables are of equal tension. If the carrier no longer stops against its stop in the slot (**M in Figure 4-4A**), but stops against the cable, then the cam must be adjusted back until the carrier once more hits its stop. It is important that the carriers come up against their stops without significant tension on the cables. If there is too much tension, the initial pull will depend on how tightly you hold the finger stops when the glass is clamped in the carriers. If this happens, the electrodes will not be consistent from pull to pull.

4.4 Regeneration of Drierite Granules

The Indicating Drierite found in the canister at the right rear corner of the base plate on the P-97 is a desiccant made of calcium sulfate (97%) and cobalt chloride (3%). This material is used to remove water vapor from the air-cooling supply system. The drierite granules become pink as they absorb moisture, eventually requiring that they be “regenerated” (dried).

4.4.1 Removing the Canister

Before proceeding, make sure the puller is off and unplug the power cord. To remove the canister from the P-97, first remove the plastic puller cover by loosening the three screws that hold it down. Next, slide the input (left) and output (right) air tubes off their white plastic connectors on the canister. Finally, the two black plastic clamps that secure the canister to the baseplate can be released by removing the screws at the base or, with older style clamps, forcing one half of the connector out of the other half at the point where they meet.

4.4.2 Replacing the Granules

Unscrew the end cap, being careful not to lose the black rubber-sealing ring that forms the airtight seal under the cap. With the cap off, the spring, the aluminum keeper, and the first filter can be removed exposing the Drierite. The exhausted granules can then be removed

from the canister. **DO NOT REMOVE THE FAR FILTER AND ALUMINUM KEEPER.** The Drierite should be spread evenly, one granule deep, on a tray and heated for one hour at about 200 degrees Celsius. The granules should then be cooled in a tight container before refilling the plastic canister. Drierite is not toxic and can be handled with few precautions. For more detailed safety information, please refer to the enclosed MATERIAL SAFETY DATA SHEET.

With the far keeper and filter in place, pour in the regenerated or new Drierite. Make sure the Drierite is well compacted set well. Next, insert the filter followed by the keeper and spring. Finally, make sure the O-ring is in the proper position in the cap and place a thin layer of vacuum grease on the O-ring. There is no need to over tighten the cover, but it should be possible to hear and feel it seating firmly against the rubber O-ring.

4.4.3 Reinstalling the Canister

Reinstall the canister on the puller baseplate with its cover to the left and the air tube connections to the front. The newer style plastic hold-downs can be tightened by reinstalling the front screws. The older style black plastic hold-downs slide inside one another and are pushed tight by hand to firmly hold the canister in place. **At this point, install the air input tube (larger tube, left-hand connector) and stop; do not install the output tube.** Plug in the puller and turn it on. The air pump will turn on and blow air through the canister. Allow this process to continue for several minutes. This procedure allows the purging of any dust or loose particles of Drierite during the recharging process. **It is critical that this dust not be blown into the output tube where it might clog either the air solenoid or the air jet.** After the purging process, you may connect the output tube and reinstall the puller cover.

If replacement is necessary, Indicating Drierite 8MESH, manufactured by W.A. Hammond Drierite Co., Ltd. (Xenia, Ohio, USA), can be purchased from Sutter Instrument and most scientific supply distributors.

(This page intentionally blank.)

5. TROUBLESHOOTING

5.1 Controlling Pipette Tip Shapes

5.1.1 Problem: What type of glass should be used?

The type of glass and the wall ratio I.D. (inside diameter) to O.D. (outside diameter) are two of the most important variables in controlling tip size. For example, using borosilicate glass with an O.D. of 1.0mm and an I.D. of 0.50mm will give tips of 0.06 to 0.07mm as demonstrated in Program 0. Using the same settings, borosilicate glass 1.0mm O.D. and 0.78mm I.D. will form tips of 0.1 to 0.12mm. Aluminosilicate glass with an O.D. of 1.0mm and an I.D. of 0.68mm will form tips of 0.03 to 0.04mm again with the same settings.

In general, the thicker the wall in relation to the O.D. of the glass the finer the tip will be, and the thinner the wall the larger the tip will be. Thin walled glass will give the best results in most experiments as it will have the largest pore for a given tip size. This means it will have a lower resistance and will allow for easier injection of solutions. However, in many cases with small cells, the thin walled glass will not form tips fine enough to obtain good penetrations. In this case, heavier walled glass must be used.

5.1.2 Problem: The resistance of pulled pipettes is too low. How can a higher-resistance pipette be pulled?

The first point to note is that there is very little correlation between tip size and electrode resistance when pulling pipettes under 0.3mm. Most of the resistance of a microelectrode is in the shank of the electrode behind the tip. Electrode tips that are 0.1 mm in diameter can vary in resistance from 20M Ω to 1000M Ω depending on the length of the electrode and what is used for the filling solution. If the same solution is used then resistance may give an indication of how well the electrode will penetrate a cell as the electrode with the higher resistance will probably have a longer shank and a smaller cone angle at the tip. This combination will aid in the penetration of cells where the cell is not a surface cell.

5.1.3 Problem: Okay, but how can tips be made even smaller.

1. The first thing to try in most cases is to increase the HEAT value. This will generally decrease the tip size but it will also give a longer shank. If the higher resistance is not a problem, this is generally the best solution. Continuing to increase the HEAT, however, is not the final answer as too high a HEAT can lead to larger tips. In general, with 1.0mm O.D. X 0.5mm I.D. borosilicate glass the finest tips will be formed when the glass pulls in 5 to 7 seconds after starting the pull.
2. If the electrode is now too long and results in a resistance too high to pass the necessary current, then the next step is to increase the pull strength. In general, a pull strength of 125 will give tips of less than 0.1mm. Increasing the pull to 250 will reduce tip size about 5-10%. We recommend a pull of about 150 in most cases.
3. The last major variable to adjust is the amount of cooling of the glass during the pull. If in the case of 1.0mm O.D. X 0.5mm I.D. borosilicate glass the pull takes place in 5-7 seconds, the tip size will not change with a change in the cooling air. The only change will be in the length of the shank. If however the HEAT is such that the pull takes place in more than 8 seconds, decreasing the cooling may somewhat decrease the tip size. Cooling

can be most effectively decreased in the P-97 by decreasing air pressure, however a decreasing TIME may also be useful.

5.1.4 Problem: How can the size of a patch-pipette be increased?

1. The first thing to try is to reduce the HEAT on the last line of the program. Try dropping the HEAT 5 units at a time to see if this will increase the size of the tips.
2. If this does not work, increase the pressure in units of 50. The PULL should generally be set to 0 when pulling large tipped (1-10 mm) pipettes.
3. See also the Step 10 under “**Step-by-step patch programming**” in the **PARAMETER ADJUSTMENT** chapter and Chapter 1 in the Pipette Cookbook.

5.1.5 Problem: Patch-pipette tips vary in size from pull to pull.

This can happen when a pipette is formed in two or more loops. If the pipette is formed in three loops in one case and then on the next pull it forms in four loops the tips will not be the same. Adding one unit in the VELOCITY value will in most cases cause the pipette to be formed in three loops or subtracting one unit should cause the pipette to form in four loops. It is always good technique when a program is developed that produces a desired pipette, to try increasing and decreasing the VELOCITY value to be sure that you are in a stable region. The best procedure in developing a very reliable pipette program is to change the VELOCITY value both up and down until the number of cycles to pull the pipette changes. Then pick a value halfway between for the final VELOCITY value.

5.1.6 Problem: Difficulty making an injection pipette with a 0.5 – 1 mm tip that also has a very short final taper and tip (20 to 50 mm long). How can this be done?

(See “Bee Stinger” pipettes in Chapter 3 of the Pipette Cookbook.)

Try a program in which the first two lines of the program have a PULL value of 0, a VELOCITY value of 10 to 30, a TIME setting of 200 and use the ramp value for the HEAT (box filament). The third line should have the same HEAT value, a PULL value of 150, a VELOCITY of 30 and the TIME should be between 0 to 50 depending on the tip needed (values may vary depending on glass characteristics).

The idea behind this program is to reduce the size of the glass on the first two cycles and then on the third cycle we give a hard pull with the air turned off. Normally if the air is turned off a long wisp will result, but since we have greatly reduced the size of the glass and with a very hard pull the glass will tend to separate when it is about 1mm in diameter.

5.1.7 Problem: The electrodes are bent. How can they be made to pull straight?

This problem occurs most often when using the trough filament. Going to a box type of filament will produce straighter pipettes. The bend in the pipette has no effect on the pipette’s tip and should cause no problems unless you are penetrating quite deep in the tissue and you are aiming at a certain site. Then the bend may lead the pipette to the wrong area. The box filament is not a complete improvement on the trough filament as the airflow is much less effective with the box filament, and you give up much of the length control that the cooling air gives with the trough filament.

5.1.8 Problem: One electrode is much longer than the other electrode.

This is caused by one of two things.

1. The filament may not be centered over the air jet. Follow the procedure “**Testing the position**” in the **Heating filament replacement** section of the Maintenance chapter.
2. If the filament is correctly centered, then the tension in the two cables that transmit the pulling force from the solenoid to the puller bars might not be equal. To check the tension and adjust if necessary, first contact Sutter Instrument to discuss the details and then follow the procedure “**Pulley Adjustment**” in the Maintenance chapter.

5.1.9 Problem: The shape and resistance of the pipette changes from pull to pull.

1. In most cases, this is due to **not** using the midpoint velocity when making a patch pipette or the program is unstable. See the Pipette Cookbook for recommended parameter settings for your application.
2. If the problem persists, then run the ramp test several times. If possible, use one long piece of glass and move the glass over after each ramp test. If the ramp values are +/- 4 units or less the problem may be with the glass. If the values are greater than +/- 4 units call Sutter Instruments.

5.2 Controller problems

5.2.1 Problem: The filament does not light up when pull is pressed.

There are a number of possible reasons why this might happen.

1. Look and see if the filament has burned out. In some cases, it may be necessary to loosen the screws holding the filament in place, as a very fine break may be hard to see.
2. If the filament is OK, try running the ramp test and see what happens. If you have just changed the filament, it is quite possible that the new filament needs a very different HEAT value than what you have been using. It is always a good idea to run the ramp test each time you change the filament.
3. If you can run a ramp test but cannot pull a pipette when using the RAMP value for the heat setting, there might be an air leak. Check to see if the air compressor is running constantly. If so, try to locate the air leak. Check tubing, connections, air solenoid, and the cap of the drierite canister. If the air compressor is not running, it is possible that the air solenoid is stuck closed or the compressor has failed. Contact Sutter Instruments for further instructions.
4. If you run the ramp test and the HEAT value reaches 999 without the filament heating up, check the tightness of the exposed connectors in the filament current pathway. These are the filament-holding screws (the screws that hold the two brass jaws and the two nuts connecting the filament wires to the posts behind the filament block).
5. If these connectors are tight then the problem is probably the power FETs on the heat sink. (Contact Sutter Instrument for further instructions.)
6. If possible, run a ramp test and verify that the values on the display appear correct: Double check that the pressure is set within the range of 200 – 500 and make sure that the air time before the pull is set to 5 seconds; continue with Item 4 above. If the SRAM memory chip battery is starting to fail, the pressure and/or the air time can be offset to <0>, in which case the filament will not heat up during a pull. Upon finding these conditions, contact Sutter Instrument Technical Support.

5.2.2 Problem: Display blank, fan not on, or locked up/overlap.

1. Check power cord and wall a.c. outlet.
2. If the unit still does not work after verifying it is properly plugged in, remove the power cord and check the fuse. If the fuse has blown, a failure in components that are not serviceable by the user has likely occurred. Contact Sutter Instrument Company Technical Support.
3. If the fuse is still good, the unit is properly plugged in, and it still does not work, a failure in components that are not serviceable by the user has likely occurred. Contact Sutter Instrument Company Technical Support.

5.2.3 Problem: Display shows only shows a cursor.

1. The microprocessor has failed to properly initialize the display. Press RESET and the display should show the proper power-up message. Always allow at least 5 seconds before turning the power back on. If the display still shows a single cursor, contact Sutter Instrument Company Technical Support.

5.2.4 Problem: Displayed program values are not correct

1. Make sure that values were not changed by another user. Always write down the program values and the ramp-test value and keep them in a secure place.
2. If the values entered are not held when the power is turned off, the embedded battery in the SRAM memory chip has probably failed. Contact Sutter Instrument Company Technical Support.

5.3 Technical Support

For further assistance, contact Sutter Instrument Technical Support at:

(415) 883-0128 or info@sutter.com

APPENDIX A. LIMITED WARRANTY

- Sutter Instrument Company, a division of Sutter Instrument Corporation, limits the warranty on this instrument to repair and replacement of defective components for two years from date of shipment, provided the instrument has been operated in accordance with the instructions outlined in this manual.
- Abuse, misuse, or unauthorized repairs will void this warranty.
- Warranty work will be performed only at the factory.
- The cost of shipment both ways is paid for by Sutter Instrument during the first three months this warranty is in effect, after which the cost is the responsibility of the customer.
- The limited warranty is as stated above and no implied or inferred liability for direct or consequential damages is intended.
- Consumables, PMTs, galvanometers, and Uniblitz^{®2} shutters are exempt from this warranty.
- An extended warranty for up to three additional years can be purchased at the time of ordering, or until the original warranty expires. For pricing and other information, please contact Sutter Instrument.

² Uniblitz[®] is a registered trademark of Vincent Associates.

(This page intentionally blank.)

APPENDIX B. ACCESSORIES

The following accessories are available for the P-97 Micropipette Puller. See <http://www.sutter.com> for more detail and availability P-97 accessories, and for part numbers not expressed in the following list.

Filaments

FB215B, FB220B, FB230B	Box Filaments: 2.0mm square, 1.5, 2.0, or 3.0 mm wide
FB255B, FB245B	Box Filaments: 2.5mm square, 2.5 or 4.5 mm wide
FB315B, FB320B, FB330B	Box Filaments: 3.0mm square, 1.5, 2.0, or 3.0 mm wide
FT315B, FT320B, FT330B, FT345B	Trough Filaments: 1.5, 2.0, 3.0, or 4.5 mm wide
FILAMENT	Platinum/iridium custom. Please contact Sutter Instrument for more information.
FS1875	Platinum/iridium sheet, 18 x 75 x 0.05 mm (0.002in)

Capillary Glass Tubing

Several sizes and types of borosilicate and aluminosilicate glass tubes are available. Please refer to Sutter Instrument's web site (www.sutter.com) for a list of part numbers.

Other Accessories

FPS	Fire polishing spacer for P-97 and P-1000 pullers
GS	Glass stop (installs on either puller bar)
CTS	Ceramic tile for scoring glass (large tips 20-200 microns)
PET	Pipette examining tile
BX10	Pipette storage box (holds 10) 4 3/4 x 3 5/8 x 3/4 inches
BX20	Pipette storage box (holds 20) 7 x 3 5/8 x 3/4 inches
V400101	Drierite (1 pound (0.45 kg) refill bottle)

(This page intentionally blank.)

APPENDIX C. FUSE REPLACEMENT

In the event that the controller fails to power up when the power switch is turned on, check the line power fuse to see if it has blown. The fuse is located in the fuse holder on the power entry module on the back of the controller. To remove the fuse holder first unplug the power cord from the power entry module. This will reveal a slot just under the edge of the fuse holder. Use a screwdriver to pry the holder straight out of the power entry module.

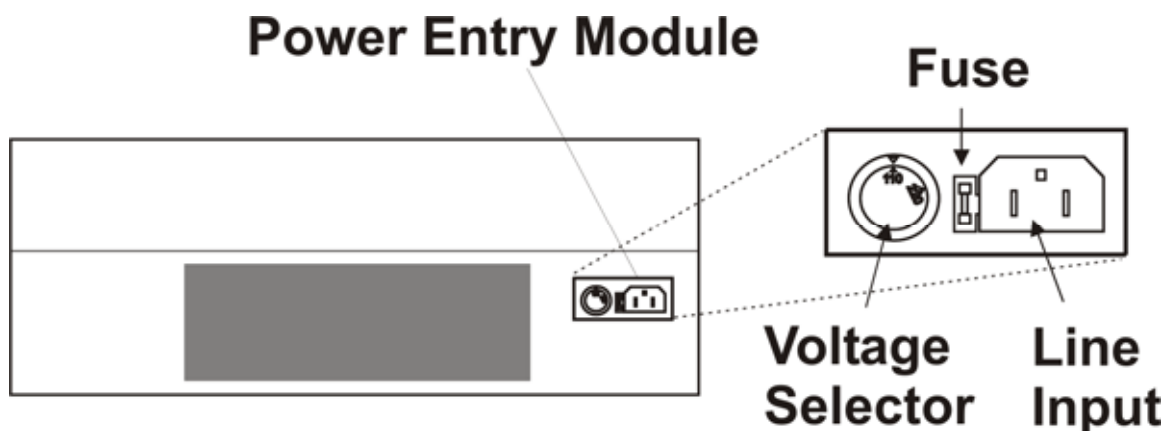

Figure 5-1. Power entry module.

The fuse that is readily visible in the fuse holder when you take it out is the one that is “active” when the holder is installed. A spare fuse is also stored within the fuse holder. It is concealed in a compartment as shown in **Figure 5-2**. To remove the spare fuse, press down on the end of the compartment and push it out of the other end. The old fuse can serve as a convenient tool for pushing the spare fuse compartment out. Replace the active fuse with the spare and re-install the fuse holder and power cord. If the controller fails to power up with the new fuse installed, call Sutter Instrument technical support personnel for assistance.

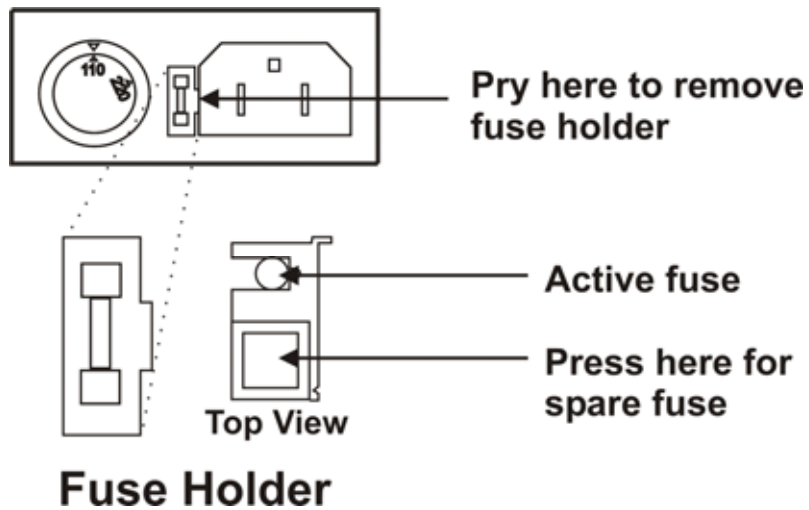

Figure 5-2. Fuse holder.



Replace fuse only with the same type and rating:

5 x 20 mm glass tube:

At 110 - 120 VAC:

Type: Medium Time Delay or Time Lag

Rating: 3A 250V (3 Amps, 250 Volts)

Examples: Bussmann GMC-3A or GMC-3-R; or
Littelfuse 239 003 or 239 003.P

At 220 - 240 VAC:

Type: Time Delay (IEC 60127-2, Sheet III)

Rating: T2A_250V (2 Amps, 250 Volts)

Examples: Bussmann GDC-2.0A, S506-2A, or S506-2R; or
Littelfuse 218 002 or 218 002.P)

APPENDIX D. TECHNICAL SPECIFICATIONS



Dimensions (H x W x D):	12 x 21 x 14 in (30 x 53 x 36 cm)
Weight:	60 lb (28 kg)
Electrical:	
Mains voltage (selectable)	110 - 120 V, 60 Hz 220 - 240 V, 50 Hz
Maximum power consumption	370 VA
Mains fuse (rear of cabinet)	5 x 20 mm glass tube
At 110 - 120 V:	
Type:	Medium Time Delay or Time Lag
Rating:	3A 250V
Examples:	Bussmann GMC-3A or GMC-3-R; or Littelfuse 239 003 or 239 003.P
At 220 - 240 V:	
Type:	Time Delay (IEC-60127-2, Sheet III)
Rating:	T2A_250V
Examples:	Bussmann GDC-2.0A, S506-2A. or S506-2R; or Littelfuse 218 002 or 218 002.P
Internal safety fuses (not operator accessible)	
Red line	Type T (slow blow), 0.5A, 250V, 3AG
Red/yellow line	Type T (slow blow), 0.5A, 250V, 3AG
Blue line	Type T (slow blow), 2.0A, 250V, 3AG
Orange line	Type T (slow blow), 6.25A, 250V, 3AG
Power cord	10A, 250V, with safety ground plug

(This page intentionally blank.)

APPENDIX E. DRIERITE MATERIAL SAFETY DATA SHEET

IDENTITY: INDICATING DRIERITE

DATE PREPARED 1-3-96

DESCRIPTION: 1/16" TO 1/4" BLUE GRANULES

SECTION I

MANUFACTURER'S NAME: W.A. HAMMOND DRIERITE CO. LTD.
ADDRESS: P.O. BOX 460,
 138 DAYTON AVE.,
 XENIA, OH 45385
EMERGENCY PHONE NUMBER: (513) 376-2927
INFORMATION PHONE NUMBER: (513) 376-2927

SECTION II

INGREDIENTS

CHEMICAL IDENTITY	%	OSHA PEL	ACGIH TLV	UNITS	C.A.S. #
CALCIUM SULFATE	97	15	10	mg/M ³	7778-18-9
COBALT CHLORIDE *(AS COBALT METAL)	3	0.05*	0.05*	mg/M ³	7646-79-9

HAZARDOUS MATERIALS IDENTIFICATION SYSTEM (HMIS)

HEALTH	FLAMMABILITY	REACTIVITY	PROTECTIVE EQUIPMENT
1	0	1	E

SECTION III

PHYSICAL/CHEMICAL CHARACTERISTICS

SPECIFIC GRAVITY:(H₂O=1): 1.87
SOLUBILITY IN WATER: 0.25 GRAMS PER LITER
MELTING POINT: 1450° C DECOMPOSES
APPEARANCE: BLUE GRANULES; NO ODOR

SECTION IV

FIRE AND EXPLOSION HAZARD DATA

FLASH POINT: NONE
EXTINGUISHING MEDIA: NOT COMBUSTIBLE
SPECIAL FIREFIGHTING PROCEDURES: NONE
UNUSUAL FIRE AND EXPLOSION HAZARDS: NONE

SECTION V

REACTIVITY DATA

STABILITY: STABLE
INCOMPATIBILITY (MATERIALS TO AVOID): STRONG ACIDS
HAZARDOUS DECOMPOSITION BYPRODUCTS: Cl₂ @ 318°C; SO₃ @ 1450°C
HAZARDOUS POLYMERIZATION: WILL NOT OCCUR

SECTION VI

HEALTH HAZARD DATA

EYES: PARTICLES MAY CAUSE IRRITATION.
SKIN: THIS MATERIAL IS NOT TOXIC. MAY DRY OR IRRITATE SKIN
INHALATION: MAY CAUSE AN IRRITATION OF RESPIRATORY ORGANS OF SENSITIVE PERSONS RESULTING IN THE OBSTRUCTION OF AIRWAYS WITH SHORTNESS OF BREATH.
INGESTION: MAY CAUSE VOMITING, DIARRHEA AND SENSATION OF WARMTH
SIGNS AND SYMPTOMS OF OVER EXPOSURE: EYE, NOSE, THROAT, OR RESPIRATORY IRRITATION

CARCINOGENICITY OF INGREDIENTS:

MATERIAL	IARC	NTP	OSHA
CALCIUM SULFATE	NOT LISTED	NOT LISTED	NOT LISTED
COBALT CHLORIDE	YES*	NO	NO

*(COBALT & COBALT COMPOUNDS ARE CLASSIFIED AS GROUP 2B)

MEDICAL CONDITIONS GENERALLY AGGRAVATED BY EXPOSURE:

PRE-EXISTING UPPER RESPIRATORY AND LUNG DISEASE SUCH AS, BUT NOT LIMITED TO, BRONCHITIS, EMPHYSEMA & ASTHMA

EMERGENCY AND FIRST AID PROCEDURES:

EYES: FLUSH WITH WATER
 DUST INHALATION: REMOVE TO FRESH AIR
 SKIN: WASH WITH WATER
 INGESTION: NONE KNOWN

SECTION VII SPILL OR LEAK PROCEDURES

STEPS TO BE TAKEN IN CASE MATERIAL IS RELEASED OR SPILLED:

SWEEP OR VACUUM MATERIAL INTO APPROPRIATE WASTE CONTAINER FOR DISPOSAL. AVOID DUSTING CONDITIONS.

WASTE DISPOSAL METHOD: THIS MATERIAL CAN BE DISPOSED OF AS AN INERT

SOLID WASTE IN AN APPROVED LAND FILL OR BY OTHER PROCEDURES ACCEPTABLE UNDER FEDERAL, STATE AND LOCAL REGULATIONS.

PRECAUTIONS TO BE TAKEN IN HANDLING AND STORING:

KEEP CONTAINER CLOSED
 STORE IN A COOL DRY PLACE
 AVOID GENERATING DUST

SECTION VIII CONTROL MEASURES

RESPIRATORY PROTECTION: NIOSH/OSHA APPROVED FOR DUST

VENTILATION: TO MEET TLV REQUIREMENTS

EYES: SAFETY GLASSES OR GOGGLES

OTHER PROTECTIVE EQUIPMENT: GLOVES OR PROTECTIVE CLOTHING ARE NOT USUALLY NECESSARY BUT MAY BE DESIRABLE IN SPECIFIC WORK SITUATIONS.

SECTION IX REFERENCES

U.S. DEPARTMENT OF LABOR - OSHA FORM APPROVED OMB NO.1218 -0072.

OSHA HAZARD COMMUNICATION STANDARD 29 CFR 1910.1200

U. S. GYPSUM CO.

Although the information and recommendation set forth herein are presented in good faith and believed to be correct as of the date hereof, the W.A. Hammond DRIERITE Co. makes no representation as to the completeness or accuracy thereof. Information is supplied upon the condition that the person receiving same will make their own determination as to its suitability for their purpose prior to use. In no event will the W.A. Hammond DRIERITE Co. be responsible for damages of any nature whatsoever resulting from the use of or reliance upon information herein supplied. No representations or warranties, either expressed or implied, of merchantability, fitness for a particular purpose of or any other nature are made hereunder with respect to information or the product to which information refers.

INDEX

- A**
- accessories 45
 - air
 - compressor5
 - Drierite canister5
 - jet.....5
 - adjustment.....5
 - nozzle5
 - nozzle adjustment.....5
 - pump5
 - solenoid5
 - valve5
 - valve solenoid5
 - air mode
 - delay 18
 - time 18
 - air nozzle
 - alignment 33
 - air pressure..... 18
 - angle plate 6, 7
 - aspiration pipettes 13
- B**
- base8
 - baseplate8
 - box filaments 30
 - bumpers.....7
 - button
 - reset.....3
- C**
- cable8
 - adjustment 35, 36
 - cable pulley assembly
 - bumpers7
 - cable8
 - panels, L/R.....7
 - pull bars 33
 - puller bars7
 - spring stops7
 - V-bearings 33
 - cable pulley assembly-bearings8
 - cables..... 35, 36
 - cables pulley assembly.....7
 - configuration
 - default 14
 - control functions 16
 - air pressure..... 18
 - ramp test 17
 - controls
 - front panel3
 - cycle
 - definition 3, 12
- D**
- date.....4
 - default configuration 14, 20
 - delay
 - definition 4, 13
 - desiccant
 - regeneration 36
 - dimensions..... 49
 - of glass1
 - disclaimer iii
 - display3
 - vacuum fluorescent display3
 - Drierite 36
 - regeneration 36
 - replacement..... 36
 - regeneration 36
 - reinstalling the canister 37
 - removing the canister..... 36
 - replacing the granules 36
 - reinstalling the canister 37
 - removing the canister..... 36
 - replacing the granules..... 36
 - Drierite canister5
 - drierite material safety data sheet 51
- F**
- features
 - new1
 - filament
 - adjustment 6, 7
 - filaments 29
 - box 30
 - geometry 31, 32
 - positioning 30, 32
 - reorder numbers 31, 32
 - replacement..... 33
 - trough 31
 - fire polish 13, 28
 - fuse
 - holder 47
 - location 47
 - replacement..... 47
 - spare..... 47
 - fuses**
 - mains**

replacement	iii	microperfusion pipettes	13
fuses, replacement		micropipette fabrication.....	22
internal	49	N	
mains.....	iii	notes	
G		user.....	56
general information.....	1	O	
glass		OD	1
dimensions.....	1	operation	20
glassware		first time use	11
alignment	34	precautions	iv
loading	11	P	
precautions	iv	P80-PC programs	19
specifications	2	P-87 programs.....	18
H		panels, L/R.....	7
heat		parameter	
definition	4	adjustment	21
heat value		Patch pipette fabrication	24
optimal setting	11	patch pipettes.....	13
heating assembly	5	pipette	
angle plate	6, 7	aspiration.....	13
eccentrics	6	holding (type)	13
heating filaments.....	See filaments	microperfusion	13
holding type pipettes	13	patch	13
I		pipette	
ID.....	1	microinjection	13
K		power	
keypad.....	3	consumption.....	49
keys		power cord	
CLR.....	3, 15	mains.....	49
ENTR.....	3	power entry module.....	47
LAST.....	3, 15	power switch	10
NEXT.....	3, 15	precautions.....	iii
numeric.....	3	electrical.....	iii
PULL	3	pressure	4
STOP	3	setting	4
L		program	
line power (mains).....	9	clearing	15
locked/unlocked.....	4	default configuration.....	20
M		definition	3, 12
mains	9	display	15
fuses	iii	editing.....	15
power consumption	49	memory.....	21
power cord	49	parameters	21
voltage.....	49	selection.....	14
memory.....	21	viewing.....	15
microinjection needle fabrication.....	22	program line	
microinjection pipettes.....	13	definition	12
		pull	
		definition	4
		pull cycle	14

pull time.....	27	technical support	2
puller bar	12	time	4
adjustment	8	definition	4, 13
alignment	7	tip shapes.....	39
puller bars	7	tip size.....	27
pulleys		troubleshooting.....	39
adjustment	35, 36	trough filaments	31
R		U	
ramp test	17	unpacking.....	9
Reinstalling the Canister	37	V	
Removing the Canister	36	V-bearings	8
Replacing the Granules.....	36	velocity	
reset.....	3	definition	4
S		special condition.....	13
safety warnings.....	iii, 48	voltage	
electrical.....	iii	mains.....	49
mains fuse.....	iii	W	
safety warnings & precautions.....	iii	warranty	43
solenoid.....	5	weight	49
spring stops	7	write protection.....	4
T			
technical specifications.....	49		

NOTES